

Gulf of Mexico Marine Assessment Program for Protected Species (GoMMAPPS): Marine Mammals Volume 1: Report



Gulf of Mexico Marine Assessment Program for Protected Species (GoMMAPPS): Marine Mammals

Volume 1: Report

June 2023

Authors:

Rappucci G, L. Garrison, M. Soldevilla, J. Ortega-Ortiz, J. Reid, L. Aichinger-Dias, K. Mullin, J. Litz

Prepared under M17PG00013

by

National Oceanic Atmospheric Administration

National Marine Fisheries Service

Southeast Fisheries Science Center

75 Virginia Beach Drive

Miami, Florida 33149

DISCLAIMER

This study was funded, in part, by the US Department of the Interior, Bureau of Ocean Energy Management (BOEM), Environmental Studies Program, Washington, DC, through Interagency Agreement Number M17PG00013 with the US Department of Commerce, National Oceanic and Atmospheric Administration, National Marine Fisheries Service, Southeast Fisheries Science Center, Miami, Florida. This report has been technically reviewed by BOEM, and it has been approved for publication. The views and conclusions contained in this document are those of the authors and should not be interpreted as representing the opinions or policies of the US Government, nor does mention of trade names or commercial products constitute endorsement or recommendation for use.

REPORT AVAILABILITY

Download a PDF file of this report at https://espis.boem.gov/Final%20Reports/BOEM_2023-042.pdf. To search for other Environmental Studies Program ongoing and completed studies, visit <https://www.boem.gov/environment/environmental-studies/environmental-studies-information/>.

CITATION

Rappucci G, Garrison LP, Soldevilla M, Ortega-Ortiz J, Reid J, Aichinger-Dias L, Mullin K, Litz J. 2023. Gulf of Mexico Marine Assessment Program for Protected Species (GoMMAPPS): marine mammals. Volume 1: report. New Orleans (LA): US Department of the Interior, Bureau of Ocean Energy Management. 104 p. Obligation No.: M17PG00013. Report No.: OCS Study BOEM 2023-042.

ABOUT THE COVER

Marine mammal photographs were collected during GoMMAPPS vessel surveys under NMFS ESA/MMPA Permit No.14450.

ACKNOWLEDGMENTS

We thank the many people who contributed to this project: Anthony Martinez, Kevin Barry, Jesse Wicker, Marjorie Foster, Katrina Ternus, Ashley Cook, Patricia Rosel, Estrella Malca, Chris Sasso, and all the field staff and crews of NOAA ships *Gunter* and *Pisces* and the NOAA Twin Otters who participated in the Southeast Fisheries Science Center (SEFSC) surveys. We also thank our GoMMAPPS partners, including Kristen Hart, Meg Lamont, Kelsey Roberts, Jeff Gleason, and Randy Wilson for their collaboration and BOEM staff Rebecca Greene, James Price, Pasquale Roscigno, and Melanie Damour for their support.

SEFSC was authorized to conduct marine mammal research activities during the surveys under Marine Mammal Protection Act (MMPA) Research Permit No. 14450, issued to the SEFSC by the National Marine Fisheries Service (NMFS), Office of Protected Resources. This study was funded by the US Department of the Interior, Bureau of Ocean Energy Management through Interagency Agreement M17PG00013 with the US Department of Commerce, National Oceanic and Atmospheric Administration (NOAA). This research was carried out [in part] under the auspices of the Cooperative Institute for Marine and Atmospheric Studies (CIMAS), and Cooperative Institute of the University of Miami and the National Oceanic and Atmospheric Administration cooperative agreements #NA15OAR4320064 and NA20OAR4320472.

Contents

List of Figures	iii
List of Tables	iv
List of Abbreviations and Acronyms	vi
1 Introduction	1
2 Methods	5
2.1 Broad-scale Aerial Surveys	5
2.1.1 Field Operations	5
2.1.2 Post-survey Processing	7
2.2 Broad-scale Vessel Surveys	7
2.2.1 Field Operations	7
2.2.2 Post-survey Processing	15
2.3 Abundance Estimation	16
2.3.1 Broad-scale Aerial Surveys	16
2.3.2 Broad-scale Vessel Surveys	19
2.4 Spatial Density Models	23
2.4.1 Environmental Data	24
2.4.2 Spatial Density Model Implementation	25
3 Results	28
3.1 Broad-scale Aerial Surveys	28
3.1.1 Field Operations	28
3.2 Broad-scale Vessel Surveys	32
3.2.1 Field Operations	32
3.3 Abundance Estimation	41
3.3.1 Broad-scale Aerial Surveys–Bottlenose and Atlantic Spotted Dolphins	42
3.3.2 Broad-scale Aerial Surveys–Sea Turtles	43
3.3.3 Broad-scale Vessel Surveys	45
3.4 Spatial Density Models	52
3.4.1 Sperm Whales	52
3.4.2 Rice’s Whales	53
3.4.3 Pygmy and/or Dwarf Sperm Whales	53
3.4.4 Beaked Whales	54
3.4.5 Short-finned Pilot Whales	54
3.4.6 Melon-headed Whales, False Killer Whales, and Pygmy Killer Whales (Blackfish)	54
3.4.7 Common Bottlenose Dolphins	55
3.4.8 Atlantic Spotted Dolphins	56
3.4.9 Risso’s Dolphins	56
3.4.10 Pantropical Spotted Dolphins	57
3.4.11 Striped Dolphins	57
3.4.12 Clymene Dolphins	58
3.4.13 Spinner Dolphins	58
3.4.14 Leatherback Turtles	58
3.4.15 Green Turtles	59
3.4.16 Kemp’s Ridley Turtles	59
3.4.17 Loggerhead Turtles	59

3.4.18 SDM Abundance Estimates Compared to Distance Sampling Abundance Estimates.....	59
4 Conclusions, Discussion, and Data Gaps	62
References	68
Appendix A: Data Auditing Protocols	73
Appendix B. Acoustic Setup Diagrams	82
Appendix E: Sperm Whale Acoustic Abundance Estimate Detailed Results	88

List of Figures

Figure 1. Planned tracklines for GoMMAPPS aerial surveys.	5
Figure 2. Twin Otter DHC-6 configuration.....	6
Figure 3. Planned tracklines for GoMMAPPS vessel surveys.....	8
Figure 4. Locations of opportunistic passive acoustic mooring servicing completed during the three 2017–2018 GoMMAPPS cruises.	13
Figure 5. Locations of CTD sampling stations during GoMMAPPS vessel surveys.....	14
Figure 6. Locations of XBT sampling stations during GoMMAPPS vessel surveys.....	14
Figure 7. Locations of plankton sampling stations during GU17-03.....	15
Figure 8. Bottlenose dolphin stock boundaries with planned aerial survey tracklines.....	18
Figure 9. Analytical strata boundaries used for vessel survey analyses.	19
Figure 10. An example time-bearing plot of sperm whale acoustic detections manually selected into click train events in PAMGuard software.	21
Figure 11. Examples of the Target Motion Analysis tool visualization in PAMGuard showing the convergence of bearing lines over time as the ship moves along the trackline to potential left and right locations for a sperm whale click train event.	22
Figure 12. GoMMAPPS 40 km ² hexagon grid.	24
Figure 13. Locations of marine mammal sightings during GoMMAPPS aerial surveys.	29
Figure 14. Locations of sea turtle sightings during GoMMAPPS aerial surveys.	31
Figure 15. Locations of marine mammal sightings during GoMMAPPS vessel surveys.....	35
Figure 16. Real-time acoustic detections from the towed array.....	37
Figure 17. Locations of sonobuoy deployments during GU17-03.	38
Figure 18. Locations of sonobuoy deployments during PC18-05.....	39
Figure 19. Sperm whale acoustic localizations for the three GoMMAPPS seasonal vessel-based surveys.	49
Figure B-1. Diagram of 4-channel towed array setup used during the summer 2017 GoMMAPPS vessel survey.....	82
Figure B-2. Diagram of towed array setup used during the winter 2018 GoMMAPPS vessel survey.....	83
Figure B-3. Diagram of towed array setup used during the summer/fall 2018 GoMMAPPS vessel survey.	84
Figure B-4. Diagram of 6-channel towed array setup used during the summer 2017 GoMMAPPS vessel survey.....	85
Figure B-5. Diagram of sonobuoy setup used during the summer 2017 GoMMAPPS vessel survey.....	86
Figure B-6. Diagram of sonobuoy setup used during the summer/fall 2018 GoMMAPPS vessel survey..	87
Figure E-1. Histograms of sperm whale group size.....	88
Figure E-2. Histograms of perpendicular distances with best fit detection function models and associated Q-Q plots for acoustically localized sperm whales on the three seasonal surveys.	90

List of Tables

Table 1. Gulf of Mexico cetacean species and habitats	2
Table 2. Opportunistic passive acoustic mooring servicing completed during the three 2017–2018 GoMMAPPS cruises.....	13
Table 3. Physiographic covariates used in spatial density models.....	25
Table 4. Dynamic covariates used in spatial density models	25
Table 5. Summary of GoMMAPPS 2017–2018 aerial survey effort	28
Table 6. Number of groups and individuals of marine mammals observed during GoMMAPPS 2017–2018 aerial surveys	28
Table 7. Number of groups and individuals of sea turtles observed during GoMMAPPS aerial surveys...	30
Table 8. Number of groups and individuals of fish observed by Team 1 during GoMMAPPS aerial surveys	32
Table 9. Summary of 2017–2018 GoMMAPPS vessel survey effort.....	32
Table 10. Number of groups and individuals of marine mammals sighted during 2017–2018 GoMMAPPS vessel surveys.....	33
Table 11. Summary of towed hydrophone array data and detections and sonobuoy data collected during the 2017–2018 GoMMAPPS cruises	36
Table 12. Fish abundance by family during summer 2017 (GU17-03).....	39
Table 13. Bottlenose and Atlantic spotted dolphin abundance estimates (CV) within stock areas from seasonal aerial surveys.....	42
Table 14. Comparison of abundance estimates for bottlenose dolphin stocks and for Atlantic spotted dolphins from the 2011–2012 aerial surveys to the 2017–2018 aerial surveys and tests of significant pairwise differences at $\alpha = 0.10$	43
Table 15. Model parameters for turtle Mark-Recapture Distance Sampling model for each sea turtle species	44
Table 16. Sea turtle abundance estimates (CV) from seasonal aerial surveys including the inverse-variance weighted average of seasonal estimates	44
Table 17. Abundance estimates (CV) from previous year large vessel cruises and GoMMAPPS summer 2017 and summer/fall 2018 surveys	47
Table 18. Post-processing results of sperm whale click train event selection and localization.....	48
Table 19. Stratified and pooled sperm whale acoustic density and abundance estimates from the three GoMMAPPS seasonal vessel-based surveys.....	51
Table 20. Comparison of sperm whale abundance estimates by analysis method.....	52
Table 21. Abundance estimates from each species derived from SDMs and standard line-transect Distance Analysis methods	61
Table A.1-1 Codes used to flag points outside the ideal survey ranges.....	76
Table A.1-2 Data auditing checks for SightingPosition.....	77
Table A.1-3 Potential SightingPosition data discrepancies and outcomes.....	77
Table A.1-4 Potential data discrepancies between Sightings and Marks tables	78
Table A.2-1 Codes used to flag points outside the ideal survey ranges.....	80

Table E-1. Models selected as best fit for detection functions from the three surveys	89
Table E-2. Kolmogorov-Smirnov goodness of fit tests of detection function model fits for sperm whale acoustic abundance estimates from the three seasonal GoMMAPPS surveys.....	91
Table E-3. Sperm whale acoustic encounter rates	92

List of Abbreviations and Acronyms

Short form	Long form
AIC	Akaike's information criterion
BOEM	Bureau of Ocean Energy Management
BSE	bay, sound, and estuary
BSEE	Bureau of Safety and Environmental Enforcement
BSS	bottom salinity
BST	bottom temperature
CDS	conventional distance sampling
CTD	conductivity, temperature, and depth
CV	coefficient of variation
DC	De Soto Canyon HARP site
DIFAR	Directional Frequency Analysis and Ranging
DOI	US Department of the Interior
DT	Dry Tortugas HARP site
DWH	<i>Deepwater Horizon</i>
EEZ	Exclusive Economic Zone
EPA	Environmental Protection Agency
ESA	Endangered Species Act
FPC	field party chief
GAM	generalized additive model
GAMM	generalized additive mixed model
GC	Green Canyon HARP site
GI	Grand Isle HARP site
GIS	geographic information system
GOF	goodness of fit
GOM	Gulf of Mexico
GoMMAPPS	Gulf of Mexico Marine Assessment Program for Protected Species
GSFM	global seafloor geomorphic features
GV	geostrophic velocity
HARP	High-frequency Acoustic Recording Package
kt	knots, unit of speed equal to 1 nautical mile per hour
LARP	Low-frequency Acoustic Recording Package
MC	Mississippi Canyon HARP site
MCDS	multiple covariate distance sampling
MLD	mixed layer depth
MMPA	Marine Mammal Protection Act
MOTU	Mark of the Unicorn
MP	Main Pass HARP site
MRD	Mississippi River Delta

Short form	Long form
MRDS	mark-recapture distance sampling
MSS	Mississippi Sound
NEPA	National Environmental Policy Act
NGOM	northern Gulf of Mexico
NMFS	National Marine Fisheries Service
NOAA	National Oceanic and Atmospheric Administration
NRDA	Natural Resource Damage Assessment
NRS	Noise Reference Station
OCS	Outer Continental Shelf
PAM	passive acoustic monitoring
PD	detection probability
PSD	perpendicular sighting distance
Q-Q	Quantile-Quantile
SARS	stock assessment reports
SCS	Scientific Computer System
SDM	spatial density model
SEFSC	Southeast Fisheries Science Center
SIO	Scripps Institution of Oceanography
SLA	sea level anomaly
SSS	sea surface salinity
SST	sea surface temperature
TMA	target motion analysis
USFWS	US Fish and Wildlife Service
USGS	US Geological Survey
XBT	expendable bathythermograph

1 Introduction

Under the Marine Mammal Protection Act (MMPA) and the Endangered Species Act (ESA), the National Marine Fisheries Service (NMFS) is charged with assessing the population status of protected species within US waters. These Acts require periodic assessment of population status relative to management and recovery benchmarks and evaluation of threats to species and populations due to anthropogenic activities. The Bureau of Ocean Energy Management (BOEM) and the Bureau of Safety and Environmental Enforcement (BSEE) require distribution and abundance information for marine protected species, including marine mammals, to assess the potential impacts of activities related to the development of offshore energy (e.g., oil and gas) and marine mineral resources as considered in federal consultations under the ESA, authorizations under the MMPA, and in compliance with other applicable statutes. As part of ESA Section 7, BOEM and BSEE are required to consult with NMFS and/or US Fish and Wildlife Service (USFWS) on listed marine mammal species that may be affected. BOEM, BSEE, NMFS, and USFWS have certain overlapping information needs to inform their assessment of the potential impacts of offshore development of energy and marine mineral resources on protected species in the US Gulf of Mexico (GOM). Therefore, the overall goal of the Gulf of Mexico Marine Assessment Program for Protected Species (GoMMAPPS) as it pertained to marine mammals was to collect broad-scale temporal information on the distribution and abundance of marine mammals in the GOM to inform seasonally- and spatially-explicit density estimates for priority species.

Twenty-one species of cetaceans (i.e., whales and dolphins) (Table 1) and the West Indian manatee (*Trichechus manatus*) are known to routinely inhabit the US waters of the GOM (Würsig et al. 2000; Maze-Foley and Mullin 2006). Manatees typically inhabit the inshore and immediate coastal waters of the northern Gulf of Mexico (NGOM), however some animals have been observed much farther offshore (Fertl et al. 2005; Hieb et al. 2017). In the US waters of the GOM, the inshore waters (bay, sounds, and estuaries) and coastal waters (out to approximately the 20-m isobath) are inhabited by common bottlenose dolphins (*Tursiops truncatus*) (Mullin et al. 1990). Bottlenose and Atlantic spotted dolphins (*Stenella frontalis*) inhabit continental shelf waters (~20 m to 200 m bottom depth) (Fulling et al. 2003). Oceanic waters (bottom depth >200 m) are inhabited by 20 species that include sperm whales (*Physeter macrocephalus*), dwarf and pygmy sperm whales (*Kogia* spp.), beaked whales (Ziphiidae), and large delphinids (e.g., short-finned pilot whales [*Globicephala macrorhynchus*], Risso's dolphins [*Grampus griseus*]) and small delphinids (e.g., pantropical spotted dolphins [*Stenella attenuata*]). Sperm whales are globally listed as “endangered” under the ESA and the GOM stock is a strategic stock under the MMPA. Rice's whales (*Balaenoptera ricei*) are a newly described species (Rosel et al. 2021) previously thought to be Bryde's whales (*Balaenoptera edeni*); they are the only baleen whales resident to the GOM, though other species of baleen whales are occasionally sighted or found stranded. Rice's whales are regularly seen only in a small area in the northeastern GOM near De Soto Canyon along the continental slope, despite significant survey efforts throughout the NGOM (Maze-Foley and Mullin 2006). Based on their localized distribution, low abundance (51 individuals, CV = 0.503), and evidence that this population represents a unique genetic lineage that exhibits very low levels of genetic diversity (Rosel and Wilcox 2014), Rice's whale is listed as “endangered” under the ESA. Currently in the US GOM, one stock is delineated for each species, except for bottlenose dolphins, which comprise 36 stocks (31 bay, sound, and estuary [BSE], 3 coastal, 1 shelf, 1 offshore), although stock structure for most of these species has not been examined and is likely inaccurate for some species (Vollmer and Rosel 2017; Hayes et al. 2022).

Five species of sea turtles: Kemp’s ridley (*Lepidochelys kempii*), loggerhead (*Caretta caretta*), green (*Chelonia mydas*), hawksbill (*Eretmochelys imbricate*), and leatherbacks (*Dermochelys coriacea*) have been reported in the GOM (Valverde and Holzwart 2017). In the GOM, the loggerhead and green turtles are listed as “threatened” and the other three species are listed as “endangered” under the ESA.

Table 1. Gulf of Mexico cetacean species and habitats

Common Name	Species	Habitat location
Rice’s whale	<i>Balaenoptera ricei</i>	Oceanic
Sperm whale	<i>Physeter macrocephalus</i>	Oceanic
Dwarf sperm whale	<i>Kogia sima</i>	Oceanic
Pygmy sperm whale	<i>Kogia breviceps</i>	Oceanic
Cuvier’s beaked whale	<i>Ziphius cavirostris</i>	Oceanic
Blainville’s beaked whale	<i>Mesoplodon densirostris</i>	Oceanic
Gervais’ beaked whale	<i>Mesoplodon europeus</i>	Oceanic
Short-finned pilot whale	<i>Globicephala macrorhynchus</i>	Oceanic
Killer whale	<i>Orcinus orca</i>	Oceanic
False killer whale	<i>Pseudorca crassidens</i>	Oceanic
Pygmy killer whale	<i>Feresa attenuata</i>	Oceanic
Melon-headed whale	<i>Peponocephala electra</i>	Oceanic
Common bottlenose dolphin	<i>Tursiops truncatus</i>	Inshore, coastal, continental shelf, oceanic
Atlantic spotted dolphin	<i>Stenella frontalis</i>	Continental shelf
Risso’s dolphin	<i>Grampus griseus</i>	Oceanic
Rough-toothed dolphin	<i>Steno bredanensis</i>	Oceanic
Fraser’s dolphin	<i>Lagenodelphis hosei</i>	Oceanic
Pantropical spotted dolphin	<i>Stenella attenuata</i>	Oceanic
Striped dolphin	<i>Stenella coeruleoalba</i>	Oceanic
Clymene dolphin	<i>Stenella clymene</i>	Oceanic
Spinner dolphin	<i>Stenella longirostris</i>	Oceanic

The primary methods for assessing population abundance and spatial distribution of marine mammals and turtles in open water are aerial and shipboard line-transect surveys (Buckland et al. 2005). These surveys typically employ visual detection of animals at the surface and, during shipboard surveys, passive acoustic monitoring to improve detection of marine mammals, particularly underwater (Barlow and Taylor 2005). Within US GOM waters, the NMFS Southeast Fisheries Science Center (SEFSC) has conducted broad-scale aerial and vessel surveys to support stock assessments since the late 1980s. Aerial surveys have primarily been used to assess marine mammals and sea turtles in waters over the continental shelf to just beyond the shelf break (Fritts et al. 1983; Scott et al. 1989; Blaylock and Hoggard 1994; Hayes et al. 2022). Oceanic waters beyond the shelf break to the boundary of the US Exclusive Economic Zone (EEZ) are most typically surveyed using large vessels (Hansen et al. 1995; Mullin and Fulling 2004), because they are logistically more efficient than aerial surveys. These historical survey programs have provided critical information supporting stock assessment and management of protected species and are the primary data source for spatially explicit models used in impact assessments. However, there were critical spatial and temporal gaps in the historical marine mammal population assessment data in the GOM that GoMMAPPS aimed to fill.

In US continental shelf waters, aerial surveys for cetaceans and sea turtles were conducted in all four seasons as part of the *Deepwater Horizon* (DWH) Natural Resource Damage Assessment (NRDA) during 2011–2012, but no survey of shelf waters had been conducted since then. For cetaceans in oceanic waters, survey data were mainly limited to spring and summer months (April–August) with the most recent surveys conducted in 2003, 2004, and 2009 ([DWH MMIQT] Deepwater Horizon Marine Mammal Injury Quantification Team 2015). The last seasonal surveys of GOM oceanic waters were conducted in the 1990s as part of the GulfCet I and GulfCet II programs and included both vessel and aerial surveys (Hansen et al. 1996; Mullin and Hoggard 2000). These GulfCet seasonal surveys were primarily focused on continental slope waters and mostly covered only part of the NGOM oceanic waters. The last non-summer vessel survey covering all US GOM waters was in the early 2000s (Mullin 2007). Before GoMMAPPS, three out of the 20 oceanic stocks had unknown abundance estimates in the NMFS Stock Assessment Reports (SARS) because the data were over eight years old, and the last survey for the remaining 17 stocks was in summer 2009. Only the three Coastal and Continental Shelf bottlenose dolphins stocks had more recent abundance data (2011–2012) (Waring et al. 2016). Therefore, updating the survey data to estimate the abundance of oceanic species was crucial for the BOEM and BSEE regulatory processes.

To achieve the main objective of the marine mammal component of GoMMAPPS, to determine the seasonal distribution and abundance of marine mammals in the NGOM, broad-scale surveys were conducted to collect data during three large vessel surveys of oceanic waters (winter, summer, and summer-fall) and three aerial surveys of continental shelf waters (winter, summer, and fall). Shipboard and aerial survey data were analyzed to estimate the density and overall population size of species encountered within the surveyed regions of the NGOM. The primary statistical approach for these analyses was distance sampling from line-transect surveys (Buckland et al. 2005). In addition to marine mammals, sea turtles were also recorded during aerial surveys and the same analytical methods were applied to estimate their abundance. This work was completed in coordination with the US Geological Survey (USGS) and is also referenced in the Sea Turtles GoMMAPPS Report¹.

Abundance estimates derived from visual line-transect surveys suffer from known negative biases (Marsh and Sinclair 1989; Laake et al. 1997) related to the critical assumption that all animals on the trackline are observed. In reality, this assumption is likely violated because some animals are not available to be detected if they are beneath the surface (i.e., availability bias) and some animals, though available to be detected, may be missed due to observer error and other factors (i.e., perception bias). Previous vessel surveys conducted in the GOM have not included approaches to correct for these biases. Additionally, in the case of deep diving marine mammals, it is particularly important to account for the availability of animals at the surface. GoMMAPPS addressed these negative biases during the surveys by employing two-team approaches (Garrison et al. 2010; [DWH MMIQT] Deepwater Horizon Marine Mammal Injury Quantification Team 2015), incorporating acoustic detections during vessel surveys (Barlow and Taylor 2005), and integrating dive-surface intervals into the estimation of sighting probability.

Data collected from GoMMAPPS will provide critical information for addressing uncertainties that are important to decision-making for multiple federal agencies and will support conservation initiatives mandated under the National Environmental Policy Act (NEPA), MMPA, ESA, and other federal statutes (e.g., Oil Pollution Act, Magnuson-Stevens Act, National Marine Sanctuaries Act, etc.). Based on bias-

¹ Lamont MM, Hart KM. In press. Gulf of Mexico Marine Assessment Program for Protected Species: sea turtles. New Orleans (LA): U.S. Department of the Interior, Bureau of Ocean Energy Management. Obligation No.: M17PG00010. Report No.: OCS Study BOEM 2023-xxx.

corrected data from the six GoMMAPPS surveys and data from historical surveys, we developed seasonal, spatially explicit maps of species density in the NGOM by estimating abundance and developing models that incorporate habitat characteristics. The data products from GoMMAPPS will ensure the exploration and development of offshore energy and marine mineral resources, and regulatory decisions related to wind energy leases balance with the mandated protection of marine species and affected habitats, particularly if they continue to be updated over time. The spatially explicit density map products will additionally benefit DWH restoration planning and monitoring at the project, resource, and ecosystem levels as well as inform management actions to reduce the risk of vessel strikes for large whales and help to understand the impacts of ocean noise on marine mammals. The resulting predictive models will also be important given variability in environmental parameters over time and how that might impact species density and distribution.

2 Methods

2.1 Broad-scale Aerial Surveys

As part of GoMMAPPS, the SEFSC conducted three seasonal aerial surveys of the NGOM continental shelf waters during the 2017 to 2018 period.

2.1.1 Field Operations

The SEFSC conducted surveys in the summer of 2017, winter of 2018, and fall of 2018 aboard a DeHavilland Twin Otter DHC-6 flying at an altitude of 183 m (600 ft) above the water surface and a speed of approximately 200 km hr⁻¹ (110 knots). Surveys were typically flown only when wind speeds were less than 15 knots (28 km hr⁻¹) or Beaufort sea state was approximately 4 or less. A total of 14,632 km of survey effort were planned for each survey. The study area extended from the shoreline to the 200-m isobath between Key West, Florida and Brownsville, Texas for the summer 2017 and fall 2018 surveys, and between Tampa, Florida and Port O'Connor, Texas for the winter 2018 survey. The federal government shutdown in 2018 led to the truncated study area for the winter survey. Surveys were conducted along tracklines oriented perpendicular to the shoreline and spaced at approximately 20-km intervals starting at a random point (Figure 1). Fine scale tracklines, spaced at approximately 5-km intervals were surveyed over Mississippi Sound waters. During the fall 2018 survey, fine-scale tracklines were added at no additional cost over Barataria Bay, Louisiana waters at approximately 6-km intervals. Due to time constraints related to weather and delays with the plane during the fall 2018 survey, the N/S-oriented Florida Keys tracklines were skipped and every other trackline was flown (40-km intervals) between Key West and Panama City, Florida.

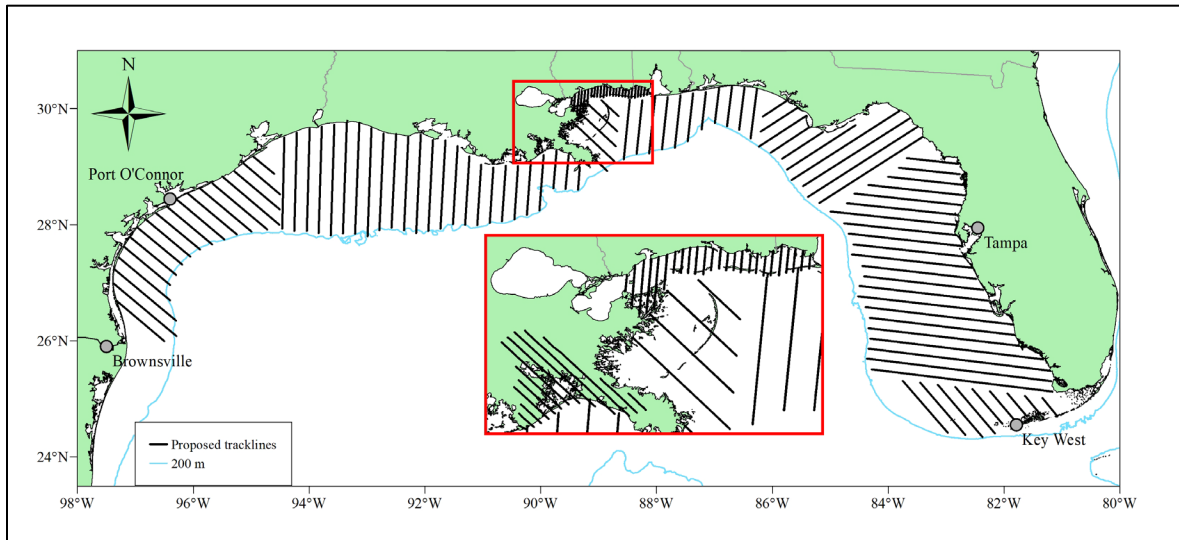

Figure 1. Planned tracklines for GoMMAPPS aerial surveys.

Inset shows fine-scale tracklines over Mississippi Sound (all 3 surveys) and added over Barataria Bay for fall 2018 only.

To conduct the surveys, eight people, two pilots and two teams each with three marine mammal observers, were onboard the airplane. Both teams implemented the independent observer approach to correct for perception bias (Laake and Borchers 2004) by operating on independent intercom headset channels so that they were not able to cue one another to sightings. The forward team (Team 1) consisted

of two observers stationed in bubble windows on the left and right side of the airplane and an associated data recorder (Figure 2). The bubble windows allowed downward visibility including the trackline. The aft team (Team 2) consisted of a belly observer looking straight down through a belly port window, who could see approximately 35 degrees on either side of the trackline, an observer stationed on the right side of the aircraft observing through a bubble window, and a dedicated data recorder. Therefore, the aft team had limited visibility of the left side of the aircraft.

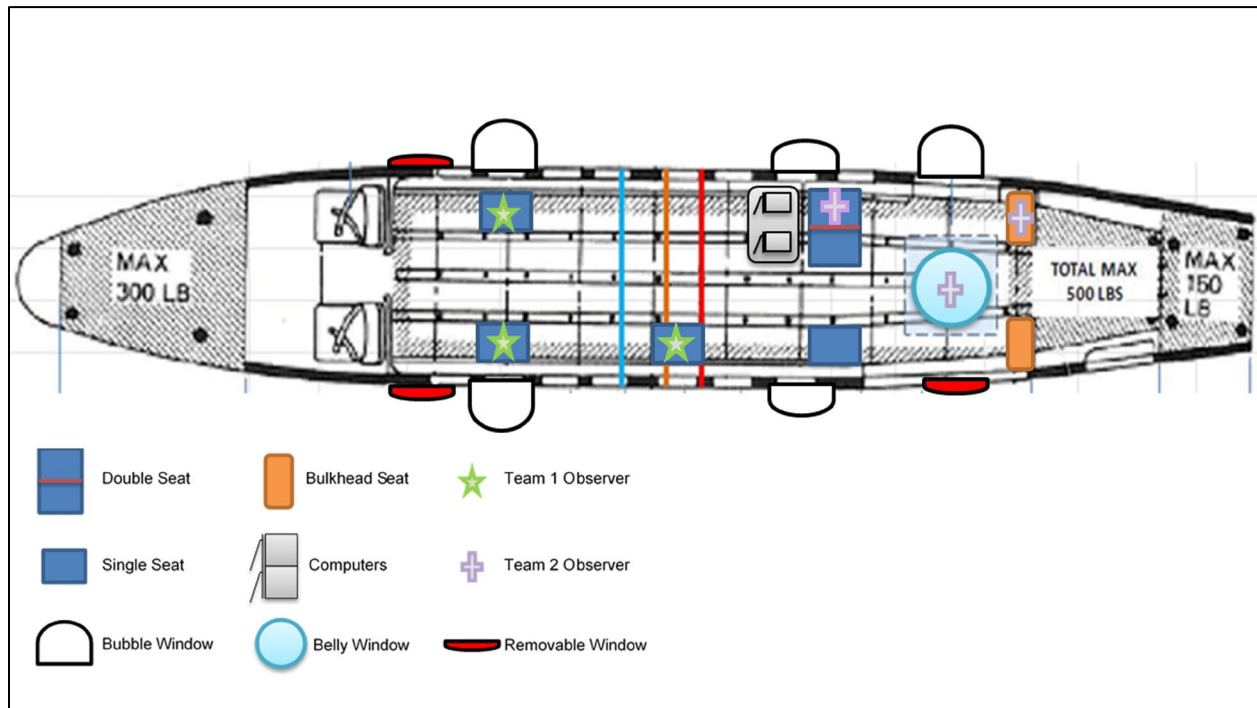

Figure 2. Twin Otter DHC-6 configuration.

The only instance in which this survey method was not used was in the beginning of the winter 2018 survey when it was not possible to hire the scientific crew needed to operate under the two-team survey approach due to a delay in the transfer of incremental funding for FY18. Between 18 January and 9 February, only the forward team—a left observer, right observer, and data recorder—was operational. After 13 February, two teams conducted the survey.

Data were entered by each team’s data recorder onto a laptop computer running data acquisition software (VisSurvey) that recorded GPS location, environmental conditions assessed by the observer team (e.g., sea state, glare, sun penetration, visibility, etc.), and effort status.

During on-effort periods (e.g., level flight at survey altitude and speed), observers searched visually from the trackline (0 degrees) to approximately 60 degrees from vertical. When a sea turtle, marine mammal, or other animal of interest was observed, the observer waited until it was perpendicular to the aircraft and then measured the angle to the animal (or the center of the group) using a digital inclinometer. The belly observer reported sighting angles in 10-degree intervals based on markings on the window (1 through 4, left or right). Fish species, including manta rays (*Manta* spp.) were recorded opportunistically.

For cetacean sightings, if the forward team initially made the sighting, they waited until it was aft of the airplane to allow the aft team an opportunity to observe the group independently. Once both teams had the opportunity to observe the group, the observers asked the pilots to break effort and circle over the sighting to verify species, estimate group sizes, and to take photographs. Only then were observers from different

teams allowed to communicate to discuss the sighting. Most cetacean sightings were circled unless the aircraft was constrained by factors such as time or fuel. The data recorders indicated at the time of the sighting whether the group was initially observed by one or both teams; a consensus on species identification and group size was entered separately on each computer.

Sea turtle sightings were recorded independently, without communication, by each team. Only turtles at or barely below the surface were identified to species, the rest were grouped as a generic category “hardshell” (the exception being leatherback turtles, which were distinct enough to identify from other species). It is worth noting that only turtles approximately greater than 30-40 cm were recorded because smaller individuals are not visible from the plane. Therefore, estimates are only for turtles of that size and bigger, i.e., neritic-stage juveniles and adults. Post survey, the turtle data were reviewed to identify matching sightings (i.e., observed by the two teams) based on time (< 15 seconds apart), location (angle difference ≤ 15 degrees), position relative to the trackline (i.e., same side of the plane), and number of animals.

2.1.2 Post-survey Processing

At the end of the aerial surveys, the team lead sent all resulting data files (Microsoft® Access databases, photographs, scanned data sheets, photographic logs, etc.) to the data manager for extensive auditing. Data auditing consisted of making corrections based on error log notes from the field, plotting trackline points to identify errors made when recording effort status, and verifying sighting data based on data sheets from the field. For detailed steps of the auditing process, see Appendix A: Data Auditing Protocols.

Once the data manager audited the Microsoft® Access database, four R scripts were run to extract data from the database, identify transect segments (i.e., segments in a survey trackline during which effort and environmental conditions were the same), overlay effort onto survey area, resolve duplicate sightings of turtles, create geographic information system (GIS) shapefiles, and format sighting data for Distance sampling analysis.

2.2 Broad-scale Vessel Surveys

As part of GoMMAPPS, the SEFSC conducted three seasonal shipboard surveys of the NGOM oceanic waters during the 2017 to 2018 period. These surveys extended from the 100-m isobath to the boundary of the US EEZ in the GOM.

2.2.1 Field Operations

2.2.1.1 Marine Mammal Visual Surveys

The SEFSC conducted surveys in the summer of 2017 and winter of 2018 onboard the NOAA Ship *Gordon Gunter* and in the summer-fall of 2018 onboard the NOAA Ship *Pisces* along predefined tracklines in a “double saw-tooth” configuration. A total of 7,480 km of survey effort were planned for each survey. Tracklines were spaced at 120 km and oriented across isobaths (Figure 3).

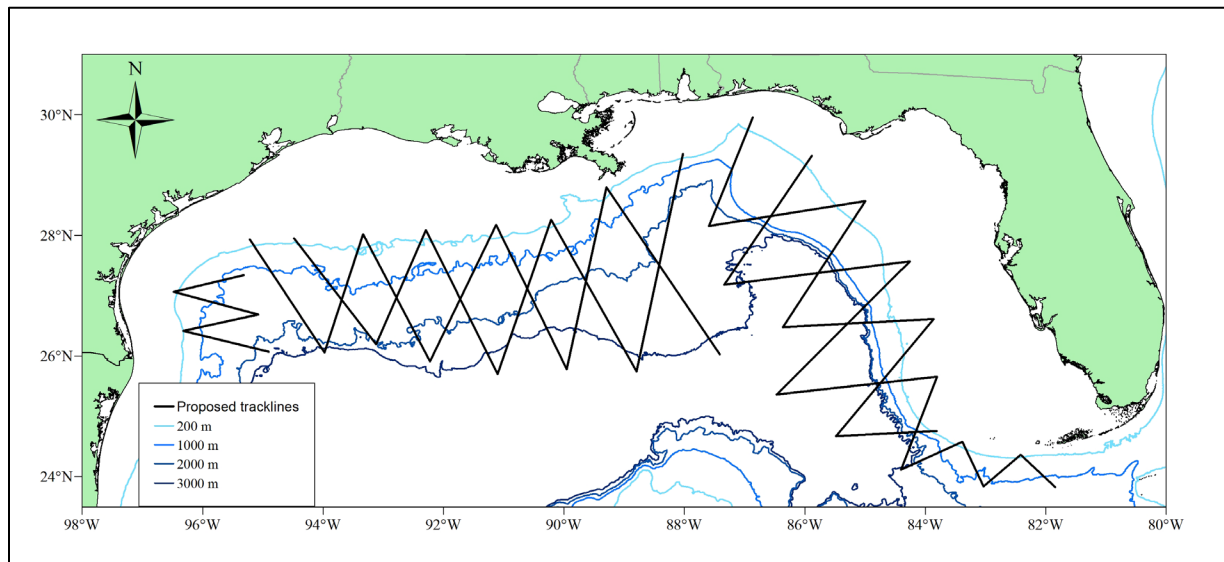

Figure 3. Planned tracklines for GoMMAPPS vessel surveys.

The surveys used the independent teams approach with Distance sampling to estimate the detection probabilities for marine mammal sightings while addressing some of the negative biases discussed above. This method used two teams of visual marine mammal observers that operated independently of one another. During this approach, one survey team with two observers was stationed on the vessel’s flying bridge (platform height above water = 13.9 m and 15.0 m for *Gordon Gunter* and *Pisces*, respectively). The second team, also with two observers, was stationed on the wings of the bridge deck (platform height above water = 11.2 m and 12.5 m for *Gordon Gunter* and *Pisces*, respectively). Each visual survey team used two pedestal-mounted, 25x150 mm “bigeye” binoculars located on the port and starboard sides of the ship. A single centralized data recorder located inside the ship’s chemistry laboratory communicated with both teams via discreet VHF channels to maintain independence of the teams. Observers used the bigeye binoculars to determine the bearing and radial distance of sightings, which were relayed to the data recorder. The location of groups sighted close to the ship without bigeye binoculars were estimated in degrees and meters. Marine mammal sightings were defined as cetacean groups consisting of one or more individuals observed at the same location and time.

The only instance in which the survey method differed was during the first two legs of the 2018 winter survey (GU18-01) when it was not possible to hire the scientific crew needed to operate under the two independent team visual survey approach due to a delay in the transfer of incremental funding for FY18. Between 14 January and 9 February, surveys were conducted by one team of three observers stationed on the vessel’s flying bridge and consisted of two observers using two pedestal-mounted 25x150 mm bigeye binoculars located on the port and starboard sides and a central observer/data recorder performing naked-eye observations.

Survey speed was typically 18 km hr^{-1} (10 kt) but varied with ship traffic and sea conditions, such as ocean currents. The data recorder used a custom written visual data acquisition program (VisSurvey) installed on a networked laptop.

A survey team was considered “on effort” whenever the ship was on a predefined trackline or transit line, at survey speed, and observers were actively searching for cetaceans through the bigeyes. Observers scanned the water using the bigeye binoculars from the beam (90° left or right depending on the side) to 10° across the ship’s bow on the opposite side; i.e., the left observer scanned from 10° right to 90° left and the right observer scanned from 10° left to 90° right. Whenever an observer suspected or had in fact

seen a marine mammal, a cue (marine mammal, splash, blow, etc.) was immediately entered in the data program and the team went “off effort.” A cue is a time and location stamp in the database that captures the spatial and temporal data of a sighting. Surveys were primarily conducted in “passing mode” whereby the ship maintains a steady course and speed along the trackline while the visual teams identify the sighting to species level, if possible, and estimate the number of individuals in the group. Previous SEFSC surveys were conducted in “closing mode” during which the vessel frequently turned to approach marine mammal groups to verify species identification and collect photographs and biopsies. However, the use of the two-team methodology required a change in methodology to allow the opportunity for both teams to detect each sighting. Passing mode surveys are expected to have a higher proportion of unidentified dolphin sightings, and this was accounted for when developing abundance estimates and spatial density models. Closing mode was used sparingly during the GoMMAPPS surveys and was restricted to sightings of special interest, including killer whales and Rice’s whales. After sightings were identified to the lowest taxonomic level possible and group size enumerated, the sighting was entered in the visual data program by the data recorder. Group size estimates were recorded independently by each observer. Observers were instructed to only enter size estimates for groups they observed entirely. Group size was counted as the minimum, maximum, and best number of animals for each sighting.

Observers were considered to be “off effort” whenever the ship was maneuvering and turning onto a new trackline, if other operations were taking place (e.g., safety drills, small boat deployment, biopsy, etc.), during bad weather (rain, sea state >6, poor visibility due to fog, lightning within 7.4 km [4 nm]), and whenever not actively searching for cetaceans through the bigeyes. Sightings observed under such conditions were recorded as off-effort. Off-effort sightings may also have included naked-eye observations and sightings detected by non-team observers, mammal observers off duty, or other crew (including ship’s crew).

For each sighting (either on- or off-effort), time, position, bearing and reticle (a measure of radial distance), species, group size, behavior, and associated animals (e.g., seabirds, fish) were recorded. An attempt was made to photograph animals that closely approached the ship. Basic survey parameters were automatically recorded by the survey program every minute and included the ship’s position, heading, effort status, observer positions, and environmental conditions (e.g., wind speed, sea surface temperature, etc.). At the start of the survey day and at then 20-minute time intervals, the survey program prompted observers for an update of the subjective environmental variables (e.g., glare, sea state, cloud cover, etc.) and sighting conditions.

2.2.1.2 Marine Mammal Biopsy Sampling

During the summer 2017 survey, tissue samples were collected from a rigid hull inflatable boat deployed by crane from the deck of the ship. The samples were collected with a crossbow fitted with a custom designed sampling dart and head to extract a small core of skin and blubber. They were subsampled for future analyses including genetics (skin stored in DMSO), stable isotopes (skin frozen at -80°C), and contaminants (blubber frozen at -80°C). All sampling was conducted by personnel with training and experience to collect biopsy samples from wild cetaceans and as authorized by the SEFSC’s MMPA permit. In the interest of time and maximizing trackline coverage, biopsy operations were limited to sightings of special interest as determined by the FPC.

No biopsy samples were collected during the 2018 surveys.

2.2.1.3 Passive Acoustic Survey

2.2.1.3.1 Towed Array

During all three vessel-based visual surveys over the 2017 to 2018 period, concurrent passive acoustic surveys for odontocetes were conducted using a modular towed hydrophone array during daylight hours when environmental conditions allowed. Passive acoustic surveys were conducted during portions of the tracklines that occurred in water depths shallower than 75 m, during rough weather conditions (sea states greater than 6), and during nearby lightning storms (within 1–2 nmi). The hydrophone array was deployed approximately 300 m behind the ship and at average depths between 7–15 m. Hydrophone depth varied depending on weighting, survey speed, ship turns, and current. With initial weighting of 6.8 kg (15 lb) of lead wire over the entire first leg of the 2017 cruise, the hydrophone array towed at 9 ± 1.5 m depth at standard survey speed of 10 kts. Before the second leg, an additional 6.8 kg (15 lb) of lead wire weight were added to the array cable, bringing the average tow depth to 12 ± 1.3 m for the second and third legs. The hydrophone depth could not be measured during the two 2018 cruises due to a faulty pressure sensor; the same weighting was used as on the 2017 cruise to maintain an expected tow depth of 12 ± 1.3 m.

These surveys used a custom-built modular towed hydrophone array that could include a mix of three components: a five-element mixed-frequency oil-filled end array, a 4-element mid-frequency oil-filled inline array, and a 30 m mid-line cable to connect the two arrays (Rankin et al. 2013). The five-element end array included paired pre-amplifier and hydrophone elements capable of recording a broad range of frequencies. Sensors 1, 3, and 5 were optimized for greater detection ranges for mid-frequency recordings by using APC International, Ltd. 42-1021 hydrophones with custom-built pre-amplifiers. The APC 42-1021 hydrophones have a -212 dB re V/uPa sensitivity with a flat frequency response (± 4 dB) from 1 to 45 kHz. The corresponding pre-amplifiers provided a highpass filter with 45 dB gain above 5 kHz. Sensors 2 and 4 were optimized for recording the full bandwidth of high-frequency echolocation signals by using Teledyne RESON TC4013 hydrophones with custom-built pre-amplifiers. The TC4013 hydrophones have a -212 dB re V/uPa sensitivity with a flat frequency response (± 2 dB) from 5 to 160 kHz. The corresponding pre-amplifiers provide a high-pass filter with 50 dB gain above 5 kHz. The 4-element inline array included the same APC 42-1021 hydrophones and custom-built pre-amplifiers as used in the 5-element end array. In addition to the paired pre-amplifier and hydrophone elements, the end array incorporated a Keller 7SE pressure sensor ahead of the hydrophones. The depth sensor data were digitized using a Measurement Computing USB-1208LS A/D converter and recorded in the software program PAMGuard (Gillespie et al. 2008). Depth sensor data were collected only on the 2017 cruise up to August 15, 2017, when the pressure sensor malfunctioned; no depth sensor data are available for the 2018 cruises.

Across the three 2017–2018 cruises, the modular towed hydrophone array was deployed in one of two configurations: 1) as only a five-element mixed-frequency oil-filled end array or 2) as a combination of a 4-element mid-frequency oil-filled inline array, 30 m mid-line cable, and the five-element end array. The combined inline and end-array configuration was used to test the ability to obtain instantaneous acoustic localizations. However, a leak occurred in the connector between the inline array and the midline cable on July 28, 2017 and the end-array only configuration was used through the remaining surveys. The 5-element end array configuration was deployed during the periods from July 2 to July 11, 2017 and from July 28, 2017 at 13:34 UTC to August 23, 2017, and throughout both 2018 cruises. In this configuration, data from end-array sensors ea1, ea2, ea4, and ea5 were digitized for recording with a custom 12-channel SailDAQ soundcard (St Andrews Instrumentation Limited) sampling 16 bits at 500 kHz, yielding 4 channels with a recording bandwidth of 1–250 kHz (Figure B-1–Figure B-4). The combined inline and end array configuration was deployed during the period from July 12 to July 28 at 12:49 UTC. Using the SailDAQ soundcard sampling 16 bits at 500 kHz, data from sensors ia1 and ia4 of the inline array along

with end-array sensors ea1, ea2, ea4, and ea5 were digitized to yield 6-channel recordings from July 12–July 22, 2017. From July 23 to July 28 at 12:49 UTC, only data from inline array sensors ia1 and ia4 and end array sensors ea1, ea4, and ea5 were digitized and recorded as a short was discovered in the inline array or midline cable circuit for end array sensor ea2 (Figure B-4). In both configurations, the SailDAQ output from sensors ea1 and ea5 was additionally routed through a custom Magrec amplifier and MOTU Traveler mk3 audio interface (Mark of the Unicorn, Inc.) for real-time aural monitoring. The SailDAQ was controlled and all digitized acoustic data and metadata were recorded to hard-disk using PAMGuard.

While the array was deployed, acoustic technicians used PAMGuard to monitor the acoustic data for acoustic signals in real-time, including logging effort and encounter details and obtaining bearings to acoustic detections. Typically, a team of two acoustic technicians rotated through a primary and on-call secondary position every 1.5–2.5 hours. During the first month of the winter 2018 cruise (14 January – 9 February), a single acoustic technician monitored throughout each day, and recorded signals went unmonitored when breaks were needed. During the summer 2018 cruise, the technicians continued to record acoustic data unmonitored when visual and acoustic surveys were suspended for lunch breaks. The acoustic technicians continuously recorded all acoustic data as four-minute, multi-channel .wav files to 2 TB external SATA hard drives. Acoustic field technicians continuously monitored data aurally and visually through spectrographic analysis using both PAMGuard and Ishmael (Mellinger 2001) software and detected and localized acoustically-active odontocetes in real-time using PAMGuard’s automated click detectors, hyperbolic bearing calculator, and manual target motion analyses as well as Ishmael’s hyperbolic bearing calculator for manually-selected whistles. Acoustic localizations were mapped and compared with visual sighting locations using a custom-written acoustic version of VisSurvey. The acoustic VisSurvey version is capable of receiving and plotting visual sighting information along with acoustic bearings and localizations to improve correlation of acoustic and visual detections in real-time. Metadata describing acoustic encounters included individual click detections with corresponding time, localization, and localization quality information.

2.2.1.3.2 Sonobuoys

During the summer 2017 and summer-fall 2018 cruises, directional sonobuoys were deployed during daylight hours, concurrent with visual surveys, for acoustic detection, localization, and recording of low-frequency sounds produced by baleen whales that are too low in frequency to be detected by the towed array system. The sonobuoy deployment strategy was to 1) deploy a single sonobuoy at predetermined stations where the trackline intersected the 250-m isobath and 2) opportunistically deploy at least two sonobuoys spaced 5 km apart within 2 km of all visually-sighted baleen whales.

The expendable Directional Frequency Analysis and Ranging (DIFAR) sonobuoys contain a compass in the sensor head and transmit three types of continuous signals back to the ship on a VHF radio carrier in an analog multiplexed format. The three signals are acoustic sound pressure, east/west particle velocity, and north/south particle velocity. The acoustic signal frequency range is approximately 10 Hz to 4,000 Hz, which is well suited for large whale vocalizations that have their greatest sound energy concentrated below 1,000 Hz. Before deployment, all sonobuoys were programmed for DIFAR mode, a hydrophone depth of 122 m, and a broadcast duration of 8 hours. On the 2017 summer cruise on the NOAA Ship *Gordon Gunter*, two omni-directional antennas (Diamond Antenna Corp. X30 144 MHz [primary] and MORAD Antenna Co. Custom 168 MHz [backup]) mounted on the aft mast of the ship at 26 m above the waterline were used to receive the VHF radio signals transmitted by the sonobuoys. On the 2018 summer cruise on *Pisces*, the two omni-direction antennas were mounted on the flying bridge, 15 m above the waterline, with the Diamond X30 144 MHz [primary] on the port side and the MORAD Custom 168 MHz [backup] on the starboard side. Advanced Receiver Research custom 140–144 MHz and P160VDG 160–170 MHz preamplifiers were used, respectively, to enhance the signal gain from the 144 MHz and

168 MHz antennas. The radio reception ranges from the sonobuoys (indicated by the presence of the DIFAR pilot tones at 7.5 and 15 kHz) reached up to 40 km, though signal quality typically began to deteriorate at approximately 20–25 km. When the ship was running at survey speed (approximately 10 kts), each sonobuoy could be effectively received and recorded for one to two hours before the ship moved out of radio reception range. However, sonobuoy sites were often located near transect turns and could be received for over two hours in these cases.

In the lab, the amplified sonobuoy signals were split and received on up to three WinRadios (G39WSBe), each tuned to the broadcast frequency programmed for one of the deployed sonobuoys. Analog signals from the three WinRadios were digitized with an RME Fireface UC audio interface sampling 24 bits at 48 kHz. Using PAMGuard (Gillespie et al. 2008) v1.15.08 software with a custom DIFAR demultiplexing module (Miller et al. 2015), the digitized acoustic data were recorded directly to computer hard drives as 1 or 2 channel, 48 kHz .wav files and transferred the recordings to 2 TB SATA disks housed in an external RAID enclosure. Additionally, PAMGuard DIFAR and Logger modules were used to record sonobuoy deployment locations, ship trackline from GPS, recording effort, and metadata logs (Figure B-5–Figure B-6). The acoustic field technicians only cursorily monitored the recordings for data quality and received radio signal strength while focusing efforts on towed array monitoring.

2.2.1.3.3 Passive Acoustic Moorings

As part of collaborative SEFSC and Scripps Institution of Oceanography (SIO) long-term passive acoustic monitoring projects, High-frequency Acoustic Recording Package (HARP) and Low-frequency Acoustic Recording Package (LARP) moorings were opportunistically serviced during the summer cruises. The HARPs continuously record sounds up to 100 kHz for up to one year with the objective of collecting calibrated long-term recordings of ambient noise and cetacean vocalizations to evaluate long-term trends in cetacean occurrence. The LARPs continuously record sounds up to 1 kHz for up to 14 months with the objective of collecting calibrated long-term recordings of ambient noise and monitoring Rice’s whale vocalizations. During the summer 2017 cruise, two HARPs deployed along the shelf break of the West Florida Shelf at the long-term Dry Tortugas (DT) and De Soto Canyon (DC) sites and a LARP from the central GOM shelf break (GI) were refurbished (Table 2, Figure 4). During the 2018 summer cruise, three long-term HARP moorings were serviced: the HARP at the Green Canyon (GC) site was refurbished, and the HARPs at the Mississippi Canyon (MC) and Main Pass (MP) sites were recovered (Table 2, Figure 4).

As part of NOAA’s Ocean Noise Reference Station Network (NRS) project, the GOM NRS06 buoy was refurbished during the winter 2018 cruise (Table 2, Figure 4). The NRS buoy was deployed to continuously record sounds up to 2.5 kHz for two years with the objective of collecting calibrated long-term recordings of ambient noise to allow comparisons of noise conditions among sites in US waters and over time.

Table 2. Opportunistic passive acoustic mooring servicing completed during the three 2017–2018 GoMMAPPS cruises

Cruise ID	Site ID	Instrument Type	Service Date	Latitude	Longitude	Action
GU17-03	DT	HARP	7 Jul 2017	25.53933	-84.62905	Refurbish
GU17-03	DC	HARP	16 Jul 2017	29.04775	-86.06528	Refurbish
GU17-03	GI	LARP	13 Aug 2017	28.62920	-90.04033	Recover
GU18-01	NRS06	NRS	9 Mar 2018	28.25017	-86.83267	Refurbish
PC18-05	GC	HARP	28 Sep 2018	27.55667	-91.16667	Refurbish
PC18-05	MP	HARP	3 Oct 2018	28.84667	-88.46500	Recover
PC18-05	MC	HARP	3 Oct 2018	29.25500	-88.29667	Recover

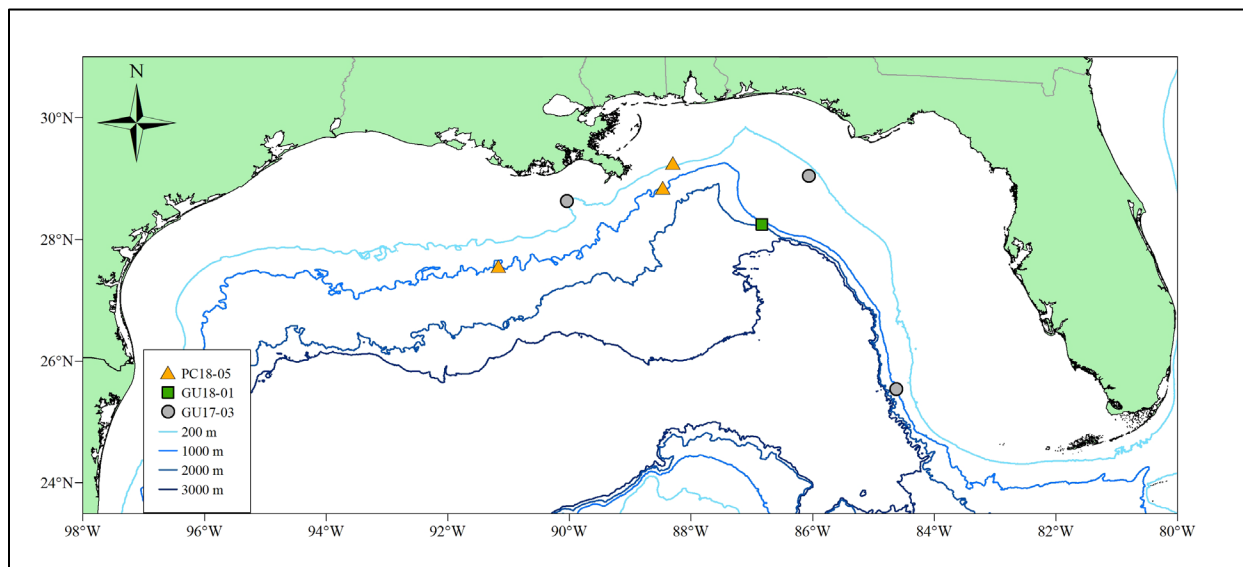

Figure 4. Locations of opportunistic passive acoustic mooring servicing completed during the three 2017–2018 GoMMAPPS cruises.

2.2.1.4 Scientific Echosounder (EK60/EK80) Data Collection

Scientific echosounder (EK60/EK80) data were collected to quantify acoustic backscatter from small fish and zooplankton beginning at sunset and until the commencement of acoustic survey effort the following day. The backscatter data are stored on hard drives for archiving and further analysis. Calibration of the EK60/EK80 was not possible during the GoMMAPPS vessel surveys.

2.2.1.5 Environmental Data Collection

Environmental data were collected at predetermined stations using a conductivity, temperature, and depth sensor (CTD) unit during all vessel surveys and expendable bathythermographs (XBT) during the summer 2017 and summer-fall 2018 surveys. Daily CTD casts recorded vertical profiles of salinity, temperature, and oxygen content at 133 stations during summer 2017, 37 stations during winter 2018, and 45 stations during summer-fall 2018 (Figure 5). In addition to the CTD casts made at the end of each marine mammal survey day during the summer of 2017, they were also made at each nighttime plankton

towing station. XBT casts recorded vertical temperature profiles at regular intervals for 225 stations during summer 2017 and 42 stations during summer-fall 2018 (Figure 6). Environmental data including water temperature, salinity, and weather conditions (e.g., wind speed, wind direction) were continuously collected in situ via the ship’s Scientific Computer System (SCS) and recorded in the visual marine mammal sighting database.

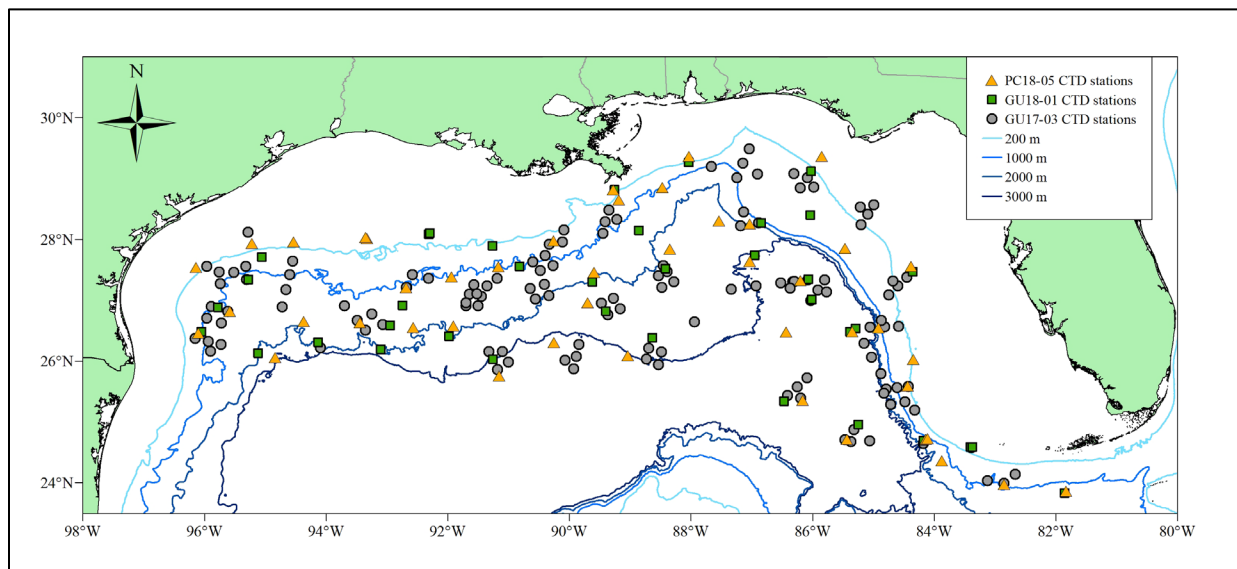

Figure 5. Locations of CTD sampling stations during GoMMAPPS vessel surveys.

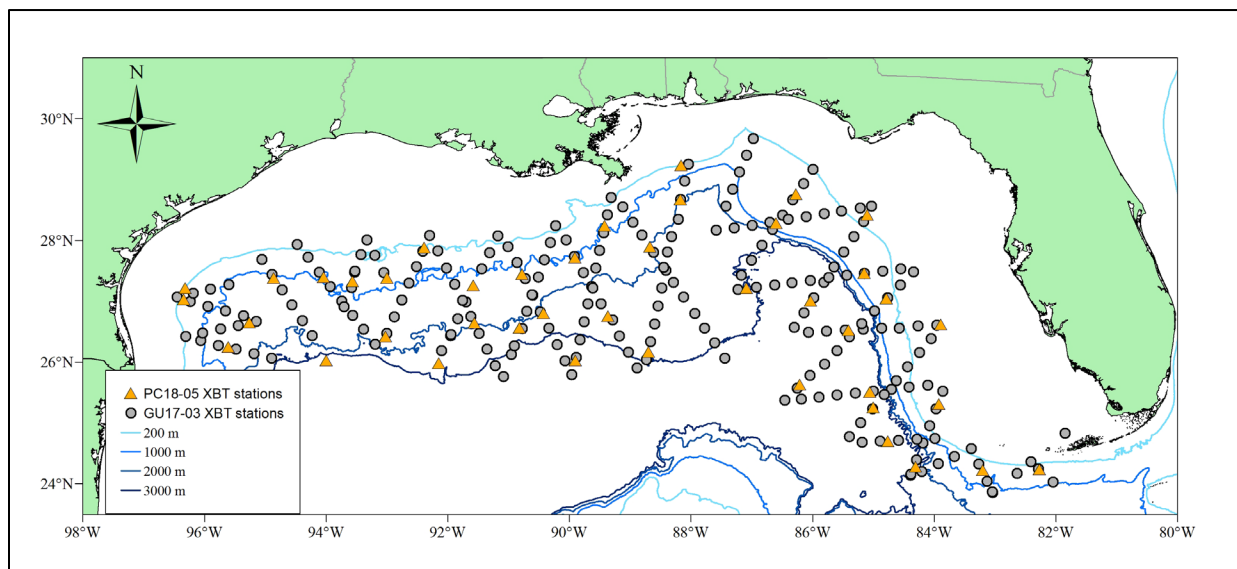

Figure 6. Locations of XBT sampling stations during GoMMAPPS vessel surveys.

2.2.1.6 Plankton Sampling

During the summer 2017 survey, scientists from the SEFSC Early Life History Lab opportunistically joined the survey and collected 136 plankton samples at night using a 90 cm bongo net, tows from the surface to 25 m depth. A mechanical flowmeter affixed to the mouth of the net calculated the volume of water sampled by each net tow. This metric is used to standardize the volume of water sampled and to

later compare overall density of plankton volume, fish, and specific taxa at each station. Stations were conducted during the evening and were placed along the survey line completed by the daytime mammal observers (Figure 7). Samples from the right bongo net were preserved and the scientists inspected a subset live on board using a stereomicroscope. They identified, measured, photographed, and immediately preserved several taxa of interest. Samples from the left net were used as a duplicate and discarded if not needed. All plankton were preserved in 95% ethanol, which was refreshed after 24 hours and as needed.

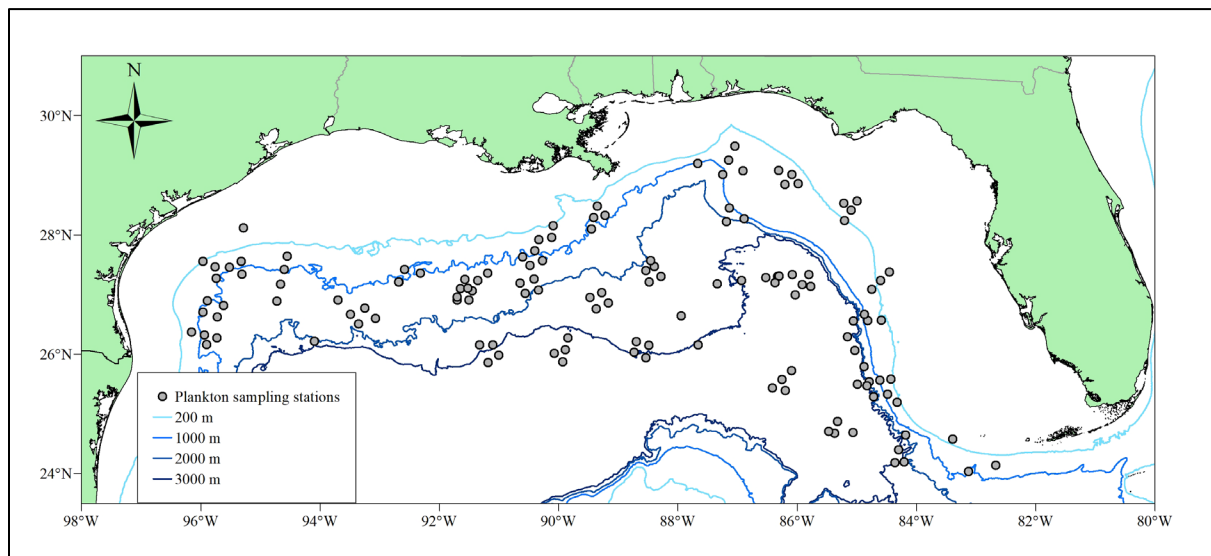

Figure 7. Locations of plankton sampling stations during GU17-03.

2.2.1.7 Seabird Visual Surveys

In collaboration with the GoMMAPPS Seabird Team, seabird observers were also present on each vessel survey and conducted counts of all birds within 300-m strip transects during the surveys. For a detailed description of survey methods and results, please refer to the Seabirds GoMMAPPS Report².

2.2.2 Post-survey Processing

At the end of the vessel surveys, the FPC or data manager transferred all resulting data files (Microsoft® Access databases, photographs, scanned data sheets, photographic logs, etc.) from an external hard drive to the SEFSC Miami lab network server for extensive auditing of the visual data. Data auditing consisted of making corrections based on error log notes from the field, plotting trackline points to identify errors made when recording effort status, and verifying sighting data based on data sheets from the field. For detailed steps of the visual data auditing process, see Appendix A: data auditing protocols.

² Gleason, JS, Sussman AL, Davis KL, Haney JC, Hixson KM, Jodice PGR, Lyons JE, Michael PE, Satgé YG, Silverman ED, Zipkin EF, Wilson RR. In press. Gulf of Mexico Marine Assessment Program for Protected Species: seabird surveys in the Northern Gulf of Mexico, 2017–2020. New Orleans (LA): U.S. Department of the Interior, Bureau of Ocean Energy Management. Obligation No.: M17PG00011. Report No.: OCS Study BOEM 2023-xxx.

Once the data manager audited the Microsoft® Access databases, two R scripts were run to extract data from the database, identify transect segments, overlay effort onto survey area polygons, create GIS shapefiles and format sighting data for distance sampling analysis.

2.3 Abundance Estimation

For both aerial and vessel surveys where two survey teams were employed, we estimated abundance using distance sampling methods (Buckland et al. 2001) and the independent observer approach assuming point independence (Laake and Borchers 2004) implemented in package MRDS (version 2.2.1, Laake et al. 2020) in the R statistical programming language. Briefly, this approach is an extension of standard line-transect distance analysis that includes direct estimation of sighting probability on the trackline. The probability of sighting a particular group is the product of two probability components. The first probability component corresponds to the “standard” sighting function such that the probability of detection (p_d) declines with increasing distance from the trackline fitting a known distribution (typically the half-normal or hazard-rate function). The selected detection probability function can include covariates (e.g., sea state, glare, swell height, etc.) that may affect the probability of detection within the surveyed region around the trackline. This is termed the Multiple Covariate Distance Sampling (MCDS) component of the model. The second component of the model estimates the probability of detection on the trackline ($p(0)$), which is modeled using a logistic regression approach and the “capture histories” of each sighting (i.e., seen by one or both teams). This component is termed the Mark-Recapture Distance Sampling (MRDS) portion of the model. The overall detection probability within the surveyed strip is the product of p_d from the MCDS model and $p(0)$ from the MRDS model. Laake and Borchers (2004) provide the details on the derivation, assumptions, and implementation of this estimation approach. All statistical analyses were performed using the R statistical programming language and package MRDS (version 2.2.1, Laake et al. 2020).

We evaluated the form of the sighting function (hazard-rate vs. half-normal) and the inclusion of covariates (including observer platform, group size, sea state, glare, swell height, wind speed, cloud cover, and survey conditions) in both components of the detection probability model and selected models based upon the Akaike’s Information Criterion (AIC; Laake and Borchers 2004). We assessed model fit through chi-square goodness of fit (GOF) tests and the Cramer-von Mises test as implemented in MRDS.

2.3.1 Broad-scale Aerial Surveys

For common bottlenose dolphins, we stratified the aerial survey effort into defined boundaries for the population stocks occupying the NGOM waters. These included three coastal stocks (Eastern, Northern, and Western), the Continental Shelf stock, the Mississippi River Delta (MRD) estuarine stock, and the Mississippi Sound (MSS) stock (Figure 8). For Atlantic spotted dolphins, the abundance estimate is for the region corresponding to the Continental Shelf stock area (i.e., 20-m isobath to shelf break). In contrast, sea turtle abundance was estimated for the entire continental shelf of the NGOM for each species.

Separate detection functions for fit for each seasonal survey (Summer 2017, Winter 2018, and Fall 2018). Covariates that may influence detection probability were evaluated for both components of the detection probability model including sea state, cloud cover, glare intensity (level of visual obstruction due to sea surface glare), glare coverage (proportion of viewing area obstructed), and turbidity. Group size was considered as a covariate, but there was no correlation between group size and detection distance for any model. All combinations of variables were considered, and the best model was selected from the candidate models based on the lowest AIC. For the mark-recapture component of the model, a distance x observer interaction term was evaluated and included in the models when needed to allow for potential

differences in detection probability estimates for the two survey teams. As noted above, the aft survey team had limited visibility on the left side of the aircraft. Thus, mammal and sea turtle groups occurring at sighting angles more than 30 degrees from vertical on the left side were not available to the aft team and were therefore removed from the analysis of $p(0)$. However, all sightings were included in the abundance estimates.

The high speed of the aircraft and the resulting short viewing interval for each marine mammal group means that sightings are essentially instantaneously available to both teams at the same time. Thus, $p(0)$ in this case is an estimate of the likelihood of at least one team on the survey detecting the group conditional on its being at the surface at the time the aircraft passed over its location. Because dolphins occur in groups of multiple animals and individual animals have relatively short dive durations, it is expected that negative bias due to all animals in a group being underwater simultaneously is small.

A similar approach was taken for sea turtles; however, a single detection probability function was selected for each species across all surveys. Unlike dolphin groups, sea turtles spend a significant amount of time underwater where they are not available to be counted by aerial observers. The amount of time below the surface varies both spatially and temporally as a function of the behavioral state of the turtles (e.g., feeding compared to traveling) and in response to environmental conditions. To account for the likelihood that a sea turtle would be beneath the surface and therefore unavailable to the survey team (i.e., availability bias), we used information derived from depth recording satellite telemetry tags deployed on leatherback, Kemp's ridley, loggerhead, and green turtles. For leatherback turtles, we used data from 27 tag deployments on turtles from the GOM. We calculated the average proportion of time in the upper 2 m of the water column during daylight hours to apply as a correction for availability (SEFSC, unpublished data). For green, loggerheads, Kemp's ridley, and unidentified hardshell turtles, we applied a generalized additive mixed model (GAMM) to predict the probability of sea turtles occupying the upper 2 m of the water column based upon an extensive database of telemetry tag data (Roberts et al. 2022). The species-specific GAMM used environmental variables to predict the probability that turtles would be near the surface and available to the aerial survey team. Environmental predictors of availability included season, sea surface temperature (SST) anomaly, water depth, the occurrence of fronts, and spatial location. The probability that each turtle observed in the aerial survey was near the surface was predicted based on the environmental conditions at the time of observation. For each hardshell turtle observed, we used the weighted average of the predicted probability that the turtle was near the surface from the three identified species models based upon the environmental conditions at the time of observation. The average was weighted by the number of sightings of each species in a given survey. The estimated density of animals at the surface was divided by the average proportion of animals near the surface to obtain corrected density and abundance estimates. The uncertainty (coefficient of variation [CV]) of the corrected abundance estimates included uncertainty from both the estimate of density at the surface and the uncertainty in the average probability that animals were near the surface.

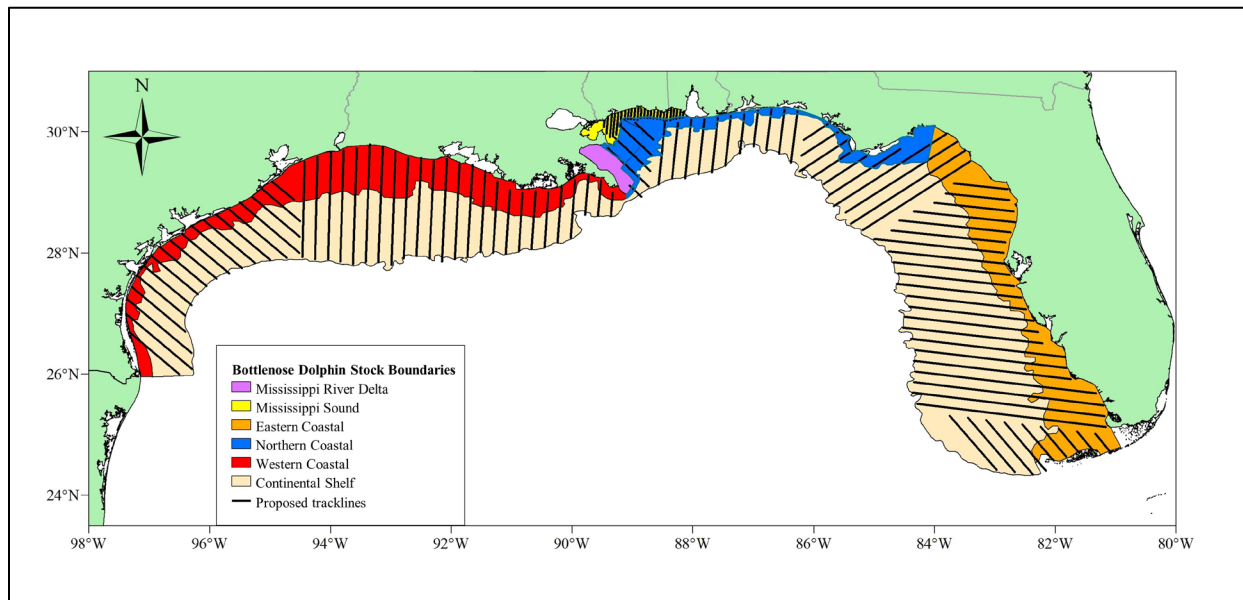

Figure 8. Bottlenose dolphin stock boundaries with planned aerial survey tracklines.

In addition to developing abundance estimates of Shelf, Coastal, and Estuarine dolphin stocks for the 2017–2018 period, there is interest in understanding abundance trends following the DWH oil spill. To evaluate possible trends in the abundance of identified species, we reanalyzed data collected during 2011–2012 as part of the NRDA associated with the DWH oil spill (Garrison 2017) to develop estimates that are directly comparable to those in the current analysis. The specific differences between this reanalysis and the estimates from Garrison (2017) are: 1) a broader suite of potential sighting condition variables was considered in the current analysis, and model selection was used to select the best model, 2) individual detection probability functions were fit to each survey whereas in Garrison (2017) a single function for detection probability on the trackline was used for all surveys, and 3) the Garrison (2017) analysis used a bootstrapping procedure to estimate variance, and the mean of the bootstrap distribution was used as the best estimate of abundance. In contrast, the current analysis uses analytical variances and means as implemented in the R package MRDS (Laake et al. 2020). To assess the statistical significance of differences in abundance between the 2011–2012 and 2017–2018 estimates for each stock, we conducted a pairwise z-test on the log-transformed abundance estimates. We interpreted significance at an alpha of $p = 0.10$ to increase the power to detect differences given the high uncertainty in the abundance estimates. For complete aerial survey abundance analysis methods for marine mammals, see Garrison et al. (2021).

Similar analytical approaches were applied for sea turtles. As with continental shelf marine mammals, abundance estimates were derived both from the GoMMAPPS surveys conducted during 2017–2018 and from seasonal surveys conducted during 2011–2012. These data allowed estimation of abundance for loggerhead, Kemp’s ridley, green, leatherback, and unidentified hardshell turtles. Detection functions were fit separately for each species across all surveys selected from the same suite of covariates described above. Abundance estimates were corrected for the likelihood that sea turtles were at the surface as predicted from the environmental conditions during each survey. For complete sea turtle aerial survey abundance methods and results, see Garrison et al. (2022).

2.3.2 Broad-scale Vessel Surveys

2.3.2.1 Visual Survey Abundance Estimates

For marine mammal visual surveys, we analyzed the survey in three strata covering the eastern, central, and western GOM between the continental shelf break and the US EEZ boundary (Figure 9) and calculated stratified abundance estimates for each individual taxa using stratum and species level encounter rates (groups/km of trackline). The strata correspond to changes in trackline orientation due to changes in the orientation of the bathymetry.

For each survey, we estimated the detection probability within the survey strip separately for four groups of cetaceans: dolphins, small whales, large whales, and “cryptic” species to account for differences in body size, surface behavior, and associated differences in sighting probability (Barlow 1995; Mullin and Fulling 2003; Garrison 2016). We grouped beaked whales and pygmy/dwarf sperm whales into “cryptic” species because these taxa have only a limited availability to visual surveys due to the long time spent underwater and difficulty in seeing them when at the surface.

As we had with the aerial survey analysis, we implemented distance sampling analysis using the independent observer approach to estimate detection probability where possible. For the “cryptic” species, there were an insufficient number of shared sightings between the two survey teams to estimate detection probability on the trackline. Therefore, we could not estimate detection probability on the trackline ($p(0)$) for these taxa and the associated abundance estimates are negatively biased. Separate detection probability functions were fit to each survey and each of the four species groups.

We apportioned unidentified taxa (e.g., unidentified dolphins, small whales, and odontocetes) among the identified taxa appropriate for each group based upon the proportional density of the identified taxa in each stratum.

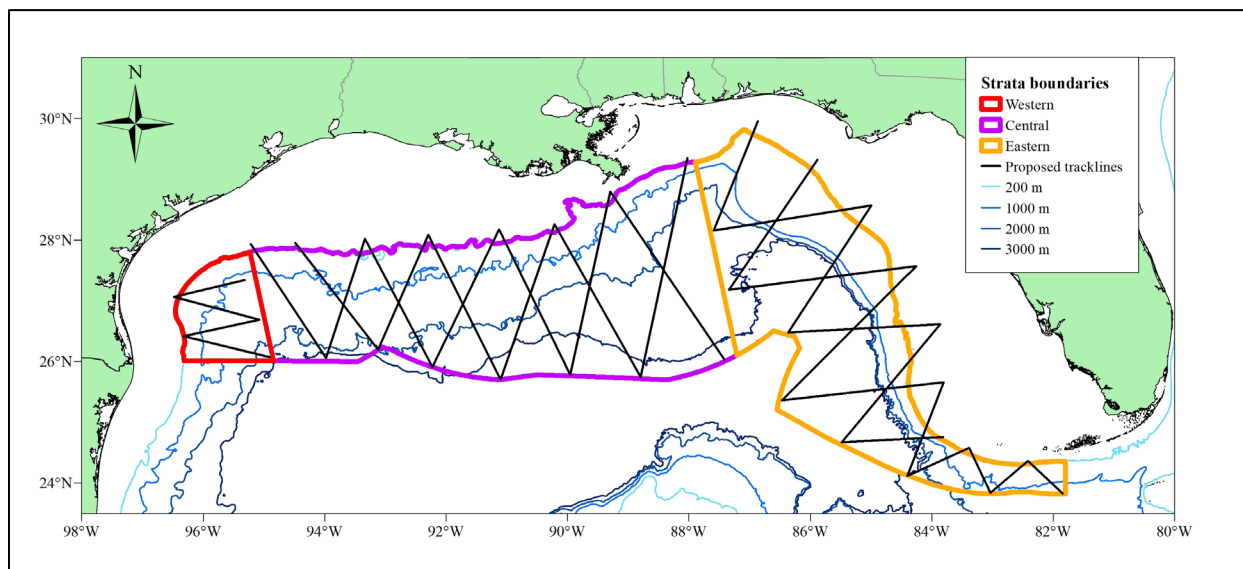

Figure 9. Analytical strata boundaries used for vessel survey analyses.

Last, to evaluate possible trends in the abundance of identified species within the NGOM, we reanalyzed visual line-transect survey data collected during the summer of 2003 (Mullin 2007), spring of 2004 (Mullin 2007), and summer of 2009 (Garrison 2016) to align with the methods used for the GoMMAPPS surveys. We stratified previous year surveys to match the current strata definitions, apportioned unidentified taxa among the identified species, and applied $p(0)$ corrections based on the results from the

2017 survey because the survey was conducted on the same vessel as the past surveys and had a similar observer configuration. To assess the statistical significance of differences in abundance between the five surveys, accounting for the uncertainty in the estimates, we conducted a pairwise z-test on the log-transformed abundance estimates. Significance was interpreted at an alpha of $p = 0.10$, and p-values were adjusted for multiple comparisons using the “Holm” method within the “p.adjust” function of the R programming language (Holm 1979; R Core Team 2020). For complete vessel survey abundance analysis methods, see Garrison et al. (2020).

We handled density and abundance estimation for Rice’s whales differently than for other GOM cetaceans due to their limited distribution and rarity. Because the Rice’s whales are observed primarily in the northeastern GOM in a relatively small area in close proximity to the 200-m isobath, the survey strata and effort used for the other species (i.e., waters deeper than ~200 m) is not representative of the Rice’s whale habitat. To address this, we post-stratified the tracklines for the 2017 and 2018 surveys (and SEFSC surveys from 2003, 2004, and 2009) to retain the survey effort within the Rice’s whale core habitat area. Further, we used Rice’s whale and unidentified baleen whale sightings from 12 vessel surveys between 2003 and 2019 to develop a detection function because there was an insufficient number of sightings during the GoMMAPPS surveys to derive a reliable detection function. There were no apparent differences in detection distances between distinctly identified Rice’s whale groups and those with uncertain identifications. Finally, there were insufficient numbers of resightings during the two-team surveys of 2017–2018 to allow an estimate of $p(0)$. Rice’s whales have relatively short dive-surface intervals, and so the likelihood that they will be available at the surface approaches 1. There were no apparent differences in detection probability as a function of sighting conditions, so it appears unlikely that there is a substantial negative bias in abundance estimates. Based upon a single detection function derived across all available survey data, we estimated abundance within the core habitat area for each of the 2003, 2004, 2009, 2017, and 2018 surveys using the MCDS approach. For additional information, see Garrison et al. (2020).

2.3.2.2 Passive Acoustic Abundance Estimates for Sperm Whales

2.3.2.2.1 Sperm Whale Acoustic Localizations

We analyzed towed hydrophone array data from the GoMMAPPS surveys to detect and localize sperm whale echolocation clicks to generate acoustic abundance estimates of sperm whales. We conducted all post processing of acoustic data using the software package PAMGuard (Gillespie et al. 2008). We ran the PAMGuard click detector over all data (pre-filter: highpass 500 Hz; trigger filter: 500 Hz to 150 kHz; threshold 12) and we manually reviewed the detections. We identified sperm whale clicks based on spectral and temporal characteristics (peak frequency, waveform and inter-pulse interval). We plotted click bearings over time and grouped clicks that had a consistent inter-pulse interval and change in bearing into click train events associated with an individual whale or closely spaced cluster of whales (Figure 10). We strove to separate click trains for individual whales whenever they were distinct enough to separate reliably; however in some cases they may include clusters of 1-3 individuals with very close bearing tracks. For each click train event, we determined a minimum, best, and maximum number of whales that were represented by the bearing track to account for trains that were clustered. For each click train event, we selected click bearings between approximately 45° and 135° for inclusion in the localization analyses, along with a click bearing at each of the start and end of the train. Clicks were often detected far ahead of the ship and showed up as a constant bearing over time at around 15° , and similarly were detected after passing at a constant bearing around 165° . We defined the start and end of trains as the point where the bearing train broke off from this constant bearing and the bearing to the whale from the ship began changing more rapidly.

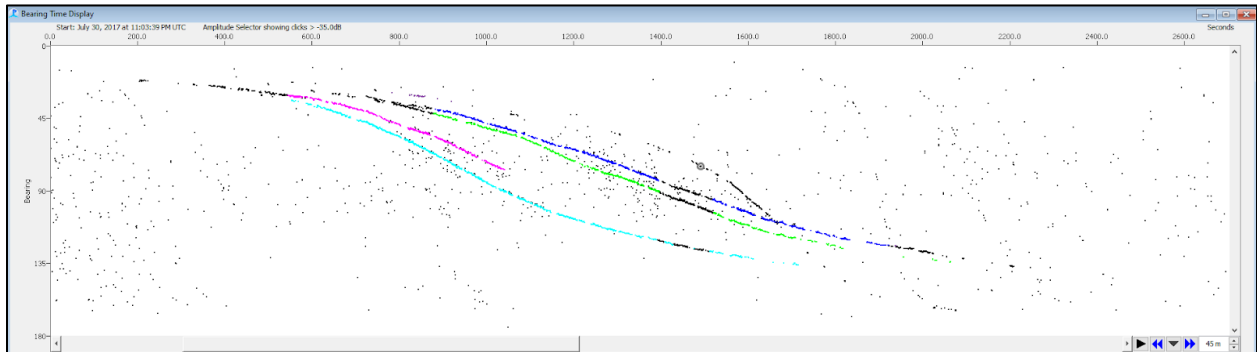

Figure 10. An example time-bearing plot of sperm whale acoustic detections manually selected into click train events in PAMGuard software.

Time is on the x-axis, bearing (relative to hydrophone one of the towed array) is on the y-axis, where 0 degrees is ahead of the vessel and 180 degrees is behind. The colored dots represent selected sperm whale echolocation clicks, with the five colors representing the unique click train events. The tracks of 5 individuals can be seen in this display along with a track from a beaked whale species (at around 1500 s). Small, scattered dots are noise.

We typically encountered multiple distinct click trains, representing multiple individuals or clusters, in the same general location at a given time, and we identified these as sperm whale groups. We defined the separation between sperm whale groups based on the following: 1) the click trains have similar slopes, but cross the beam (90°) more than 10 min apart (this is ~3 km at 18 km/h transit speeds); 2) the click train slopes differ by more than 10° per min (which is approximately a separation of 4 km at beam), or 3) if call types differ, suggesting a difference in behavior (e.g., codas and echolocation). Each individual (or close cluster) was assigned a group ID and an individual ID within that group, and minimum, best, and maximum group size estimates were documented to assist in quantifying total individuals detected for comparison with total individuals localized, as some individuals could not be localized due to ship turns or changes in acoustic effort. Note this group size represents the whole group of whales in an acoustic encounter and may include multiple click train clusters (described above).

We localized click train events using PAMGuard’s target motion analysis (TMA) tool which combines ship track and click train event bearing information, and, using the 2-D simplex algorithm, determines the beam crossing time and perpendicular distance from the trackline, with associated uncertainty, along with the latitude and longitude of the localization for each click train event. Acoustic localizations from a linear-array have left-right ambiguity when the vessel travels in a straight line so these parameters were estimated for both the left and right localizations (Figure 11A). Less commonly, the correct side can be determined if the vessel turns during an encounter (Figure 11B). We manually selected the output for the correct side when it could be determined. In some instances, whales were detected where two tracklines met. Tracklines were considered independent sampling units and any whales that could be independently localized to a trackline were included as detections on that trackline, and click train events localized on both tracklines were linked when possible to assist in determining the correct side.

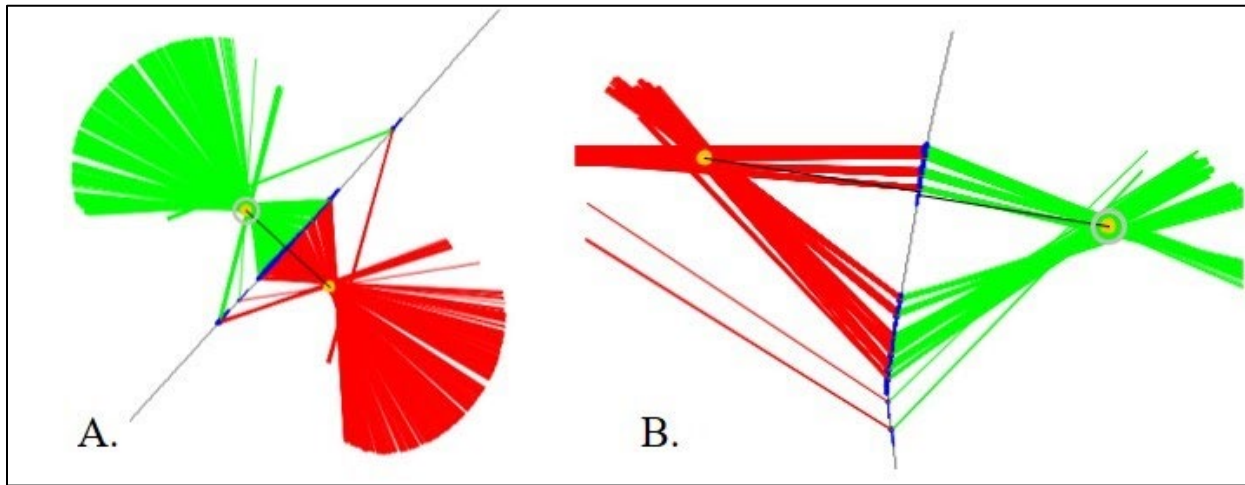

Figure 11. Examples of the Target Motion Analysis tool visualization in PAMGuard showing the convergence of bearing lines over time as the ship moves along the trackline to potential left and right locations for a sperm whale click train event.

The image in (A) highlights the left/right ambiguity from 2d towed array data when the vessel travels in a straight line, while (B) demonstrates how side (green) can be determined from a turn in the vessel track.

As part of the TMA localization process, we assigned several quality assessment factors to each click train event to document variation in localization quality related to consistency in click production and detection, which was particularly important for cases with larger groups of sperm whales and during ship turns. The quality assessment factors included the following: 1) the number of clicks available for TMA; 2) the continuity of the click train (e.g., whether the click train crosses path or merges with another click train or abruptly ends and potentially restarts); 3) the consistency of the click train determining how clear the train is in order to follow it through the whole event; 4) whether start and end times of the events were recorded; 5) the tightness of the bearing lines where they cross; 6) whether the majority of the clicks are ahead, crossing, or behind the beam; 7) whether left or right side location can be confidently determined; and 8) whether a true perpendicular distance line was calculated from the track at beam crossing (ship turns or breaks in effort affect this parameter). Additional event-specific comments were also noted as needed to understand the TMA estimation quality, such as information on abrupt starts or stops of click trains suggesting potential starts or ends of dives and surface events, TMAs with skew likely due to current, etc.

The TMA parameter estimates and quality assessment data were stored in a SQLite database and exported as .csv files for further processing with custom algorithms written in Matlab (Mathworks, Natick, MA) to prepare the data for distance sampling analyses. Ship-based GPS data and acoustic effort data were also used for this preparation. Custom code was developed to 1) assign trackline and stratum information to each ship track GPS sample, 2) calculate kilometers of acoustic effort per trackline per stratum, 3) assign trackline and stratum information to each acoustic sperm whale click train event, 4) re-calculate the left and right perpendicular distances based on a projected track line from the vessel location at the start of the click train encounter, 5) estimate horizontal distances from perpendicular “slant” distances assuming whales are at depth rather than at the surface (further details below), 6) calculate the inverse-variance-weighted mean perpendicular distance from both sides, or extract single perpendicular distances when side is known, for depth-corrected distances for each event, and 7) prepare output tables of Stratum, Area, Transect, Effort distance, Perpendicular distance, Cluster size, Group ID and Individual ID in the format required for Distance software.

Standard Distance sampling techniques for visual surveys are developed in 2-dimensions using the horizontal distance from the trackline and are suitable for whales seen at the surface while surfacing to breathe. However, passive acoustic methods sample the animals as they dive throughout the water column. For sperm whales, which typically dive to depths between 500 and 1500 m to forage, TMA methods are estimating the slant range (i.e., the hypotenuse of horizontal distance and depth) and not the horizontal distance. This means that a whale on the trackline at 1000 m depth will be estimated to be at 1000 m horizontal distance, rather than 0 m horizontal distance; the depth effect biasing the horizontal distance estimation is greatest at the trackline and decreases with increasing true horizontal distance from the trackline. In the GOM, the mean foraging depth of tagged sperm whales is 800 m (Watwood et al. 2006). To correct for the slant range impact on acoustic sperm whale density estimates, depth-corrected horizontal distances were estimated, using Pythagorean Theorem, in which 1) all whales with perpendicular distances estimates greater than 800 m were assumed to be at 800 m depth, and 2) all whales with perpendicular distances estimates of 800 m or less were assumed to be at a depth selected from a uniform distribution from the surface to 800 m.

2.3.2.2.2 Acoustic Sperm Whale Abundance Estimation

For each survey, sperm whale density and abundance for the three NGOM strata were estimated from the acoustic localizations using the software package Distance 7.3 Release 2 (Thomas et al. 2010), a custom software program designed to estimate abundance from line-transect surveys. For each seasonal survey, we estimated density and abundance using conventional distance sampling (CDS) models within Distance, such that detection functions and cluster size were estimated on data from the entire survey, encounter rate was estimated per stratum, and density and abundance were estimated at both the stratum and survey levels. Similar to visual sightings, the probability of acoustic detection declines with increasing distance from the trackline, and the probability of detection is estimated by a detection function. We evaluated the form of several standard detection function models (uniform key with cosine adjustments; half-normal key with cosine adjustments; half-normal key with Hermite polynomial adjustments; and hazard-rate key with simple polynomial adjustments) and selected models based upon the AIC (Laake and Borchers 2004). We assessed model fit through Kolmogorov-Smirnov GOF tests and the Cramer-von Mises test, as well as by evaluating Quantile-Quantile (Q-Q) plots output by the Distance software. Separate detection probability models were fit for each seasonal survey. For these surveys, we right-truncated the perpendicular sighting distances to remove roughly 5% of the sightings with the farthest distances to avoid models with overfitting of the right tail of the distribution (Buckland et al. 2001). Resulting abundance estimates are negatively biased due to the assumption that detection probability on the trackline ($g(0)$) is equal to 1. We discuss the potential sources of bias below.

2.4 Spatial Density Models

We developed habitat-based species distribution models using a generalized additive model (GAM) framework to determine the relationship between cetacean abundance and environmental variables (Becker et al. 2012; Best et al. 2012; Miller et al. 2013). Survey effort and environmental variables were summarized with a hexagon grid developed by the Environmental Protection Agency (White et al. 1992) expanded to fit the entire GOM (Figure 12). The grid was created in a Lambert azimuthal equal area projection and the area of each hexagon is 40 km². For all hexagons that contained survey effort segments, we summarized total number of each species observed, effort length, and average sighting condition covariates in the hexagon.

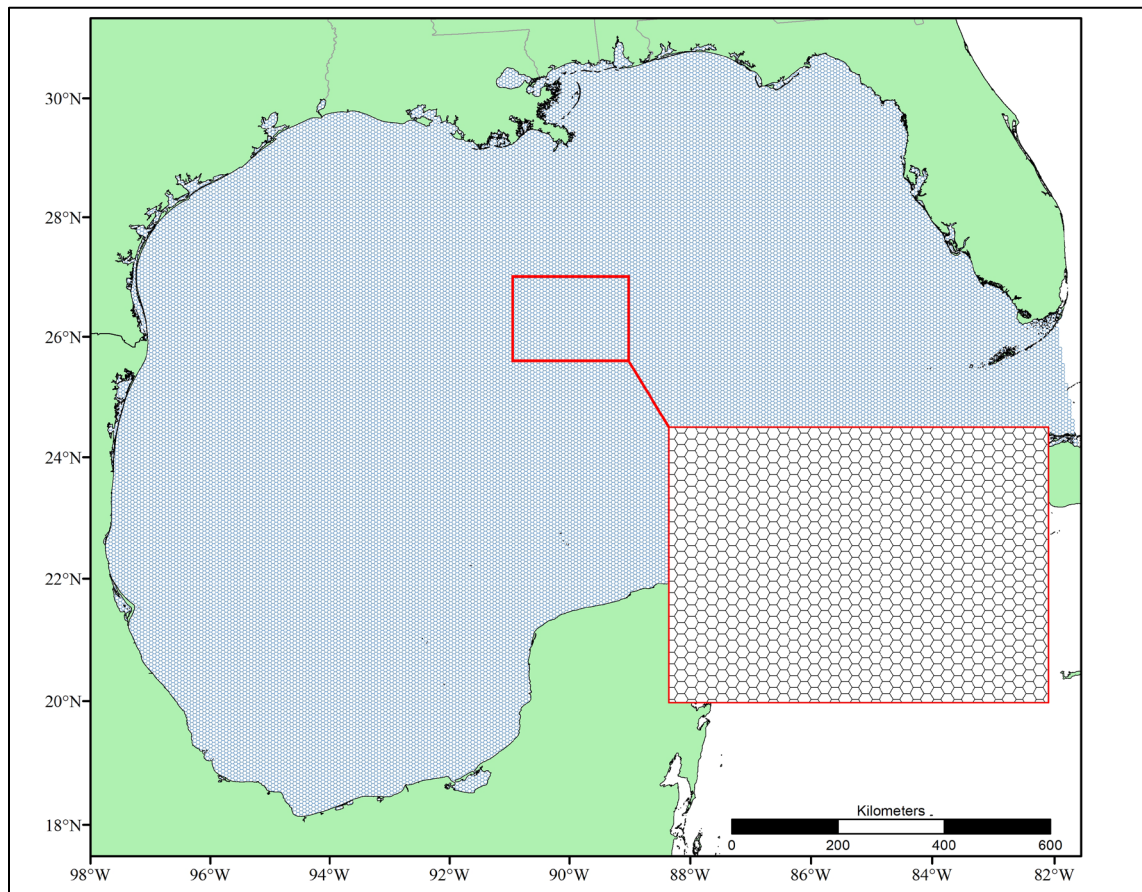

Figure 12. GoMMAPPS 40 km² hexagon grid.

2.4.1 Environmental Data

Bottom depth was extracted from the Shuttle Radar Topography Mapping (SRTM30_plus) database (Becker et al. 2009), which has a 30 arc seconds (nominal) resolution. We used Esri® ArcMap to calculate slope (in degrees) from the SRTM30_plus raster for our study area, which had a pixel resolution of 1244 x 1129 meters.

We obtained a digital map of the GOM coastline from the full resolution Global Self-consistent Hierarchical High-resolution Geography database (Wessel and Smith 1996)³. We also obtained a digital map of global seafloor geomorphic features (GSFM) created by Harris et al. (2014). GSFM is a collection of GIS vector maps of oceanic regions generated by the analysis bathymetric contours derived from SRTM30_plus. We estimated distance from the centroid of each hexagon in the grid to the features on the digital maps described above to obtain these derived variables: distance to shore, distance to the boundary of the continental shelf edge and distance to canyons (Table 3).

³ Available from <https://www.ngdc.noaa.gov/mgg/shorelines/>

Table 3. Physiographic covariates used in spatial density models

Covariate	Description	Resolution	Data Source
Depth	Seafloor depth (m)	30 arc sec	SRTM30 (Becker et al. 2009)
Slope	Seafloor slope (°)	30 arc sec	SRTM30 (Becker et al. 2009)
Dist2Shore	Distance to shore (km)	N/A	Calculated (Harris et al. 2014)
Dist2Canyon	Distance to canyon (km)	N/A	Calculated (Harris et al. 2014)
Dist2Shelf	Distance to shelf (km)	N/A	Calculated (Harris et al. 2014)

Oceanographic variables were used as dynamic covariates in SDMs and were obtained from multiple sources (Table 4). These included both remotely sensed data and hydrographic model output. Data products were obtained from their respective sources at varying temporal and spatial resolutions. To develop the explanatory variables for the SDMs, we summarized each data source spatially by overlaying the hexagon grid and calculating the average variable for each cell at the highest temporal resolution available. These data were then matched to the survey effort data so that each trackline segment in each grid cell is associated with contemporaneous environmental conditions. The survey effort segments were the sampling unit in the spatial density models (SDMs). For prediction maps, we developed monthly averages of the gridded data for all survey years 2003–2018.

Table 4. Dynamic covariates used in spatial density models

Covariate	Description	Resolution	Data Source
SST	Sea surface temperature (°C)	0.01°, daily	PO.DAAC G1SST
Chl-a	Chlorophyll-a concentration (mg m ⁻³)	4 km, daily	NASA MODIS-Aqua
u, v	Surface current velocity (m/s)	1/25°, daily	HYCOM
MLD	Mixed layer depth	1/25°, daily	HYCOM
SLA	Sea surface height (Surface Level) anomaly	1/6°, 5 days	PO.DAAC TOPEX/Poseidon, Jason-1, Jason-2, and Jason-3
SSS	Salinity (psu)	1/4°, 8 days	PO.DAAC SMAP

2.4.2 Spatial Density Model Implementation

Surveys conducted during the GoMMAPPS project and comparable prior year surveys were used to develop SDMs for marine mammal species occupying continental shelf and oceanic waters of the NGOM. Aerial survey data from seasonal surveys conducted during 2011–2012 (NRDA surveys described above) and 2017–2018 (GoMMAPPS Surveys) were used to develop SDMs for species over the continental shelf. Data collected from vessel surveys during the two-team surveys conducted during summer 2017, winter 2018, summer-fall 2018, and single-team surveys conducted during summer 2003, spring 2004, and summer 2009 were used to develop SDMs for marine mammals in oceanic waters. SDMs include a combination of two modeling approaches to address potential sources of bias and develop species-habitat relationships that are used to develop spatially and temporally explicit predictions of animal density (Miller et al. 2013).

First, the probability of detection within the surveyed strip is derived using Distance sampling methods described above. For aerial surveys, two survey teams were used in all surveys, and a combined MRDS model was developed to estimate detection probability in the survey strip. In the case of vessel surveys, a detection probability function was estimated using data from the flying bridge survey team for all surveys (2003–2018) using multiple covariate distance (MCDS) function models. The probability of detection on

the trackline was developed using MRDS methods from the 2017–2018 surveys, and the resulting model was applied to the single observer surveys conducted in 2003, 2004, and 2009. As noted above, it was not possible to derive an MRDS model for beaked whales, *Kogia* spp., or Rice’s whales.

For each species or species group, the best MCDS model was selected by first examining the distribution of perpendicular sighting distances and selecting an appropriate right truncation distance and key function. Then, all combinations of detection covariates were considered, and the model with the lowest AIC was selected. For the MCDS model, the relationship between group size and detection distance was examined, and the log of group size was included as a covariate where there was a statistically significant correlation. Following selection of the MCDS portion of the model, detection probability covariates including sea state, swell height, and visibility were considered for inclusion in the MRDS model along with distance from the trackline and observer platform (flying bridge or bridge wings). The selected covariates and MRDS model varied by species or species group (see Appendices C and D). In contrast to the abundance estimates described above, a single detection probability function was used across all surveys for each species or species group.

The selected MRDS model is used to calculate the detection probability within the surveyed strip (p_j), a GAM was implemented to quantify species-habitat relationships following the approach described in Miller et al. (2013). The sampling units for the SDM model were the segments of “on-effort” trackline within each grid cell for each survey. For each segment (j), the effective searched area ($A_j p_j$) was calculated as the product of the segment length (l_j), the surveyed strip width (w) (based on the truncation distance from the MRDS model; $A_j = 2l_j w$), and the estimated detection probability (p_j) within the segment predicted from the MRDS model and the appropriate detection probability covariates on the survey strip. This searched area was included as an offset term in a GAM that predicts the counts of animals (n_j) per segment (Miller et al. 2013):

$$n_j = A_j p_j \exp \left[\beta_0 + \sum_k f_k(z_k) \right]$$

Animal counts are modeled smooth functions (f_k) of k environmental variables (z_k) with an intercept term (β_0). The model assumed a Tweedie error distribution to account for overdispersed (i.e., zero-inflated) count data. An initial model was fit using all available oceanographic and physiographic variables. A reduced model was then selected including only model terms with p-value < 0.2. This reduced model was compared to the full model using AIC to ensure selection of the best fitting, most parsimonious model. Model fit was assessed through the examination of randomized quantile residuals and the associated Q-Q plot for deviance residuals.

Deep-diving sperm whales and beaked whales spend a significant amount of time executing deep feeding dives, and thus are often not available to the visual survey teams. Though the two-team approach accounts for the likelihood of detection on the trackline of groups that are available at the surface, it does not account for those that are underwater while in the viewing area of the vessel. For these two taxa, we applied an additional correction for availability based upon equations described in Laake et al. (1997). Tag data that recorded sperm whale or beaked whale dive-surface behavior were reviewed to obtain estimated dive and surface durations. For these species, the observed animal counts were divided by this correction factor, and the corrected counts were used as the response variable in the SDM to obtain an unbiased estimate of sperm whale and beaked whale density and abundance.

As noted above, there were significant numbers of dolphin and small whale groups during the vessel surveys that could not be identified to species due to the distance at which they were observed or sighting conditions. Also, a number of dolphin sightings could only be identified to the genus *Stenella*. Excluding these unidentified sightings from the analysis would result in a significant negative bias in the resulting density estimates from the SDMs and limit the reliability of comparisons of density across survey years. Therefore, separate SDMs were developed for these three groups of unidentified taxa. The unidentified animals were then apportioned among the appropriate identified species based upon their relative predicted density in each spatial cell. The final resulting SDMs therefore account for both identified and unidentified sightings in a manner similar to the abundance estimates described above.

Prediction maps were developed for each species or species group based upon the monthly averaged oceanographic conditions during 2018. The appropriate SDM was used to predict animal density in each 40 km² spatial cell in the NGOM for either shelf or oceanic waters for each month. The CV of the density estimate (based upon uncertainty in the GAM model fit) is used to display the level of precision of the model and identify regions of high density and high uncertainty where model extrapolation is less reliable. Abundance estimates for each month are the sum of predicted abundance in each spatial cell. These estimates vary in response to dynamic oceanographic variables. Finally, the models were extrapolated beyond the NGOM to provide insight into potential high-density areas throughout the GOM. However, extrapolations of this type should be interpreted with caution.

To account for inter-annual variability in environmental conditions, prediction maps were generated using monthly environmental parameters for the period 2015–2019. The posterior distribution of the GAM parameters was sampled 1,000 times to generate a distribution of model coefficients that reflect the statistical uncertainty in the parameter estimation. Predictions of animal density were generated for each month in the 2015–2019 period based on each of these 1,000-parameter sets. In this way, both inter-annual variability in environmental conditions and model uncertainty were included in the resulting samples. The monthly predictions were examined to identify sampled parameters that generated extreme predicted densities, and these extreme values were excluded from the bootstrap sample before variance estimation. These extreme values, associated with density predictions many orders of magnitude higher than the observed median, reflect projection of the model predictions into poorly sampled parameter space. The resulting trimmed distribution of realizations was used to summarize predicted average densities by month and to calculate metrics of uncertainty. The resulting monthly density maps for both the NGOM and extrapolated into the southern GOM, monthly estimates of abundance, and seasonal and/or regional estimates of abundance are provided for each marine mammal species or species group.

Additional specifics of methodology and model results for each species or species group are described in independent species reports in Appendices C and D to this report.

3 Results

3.1 Broad-scale Aerial Surveys

3.1.1 Field Operations

The three GoMMAPPS aerial surveys resulted in a total of 34,464 km of trackline surveyed on effort, and 847 marine mammal sightings that included 5,866 recorded individuals (Table 5). Nearly 95% of the sightings were common bottlenose dolphins, and 3% were Atlantic spotted dolphins. Manatee sightings were recorded during the summer and winter surveys and there was one sighting of rough-toothed dolphins (*Steno bredanensis*) in the summer (Table 6, Figure 13).

Table 5. Summary of GoMMAPPS 2017–2018 aerial survey effort

Survey	Dates	Flight days	Effort (km)
Summer 2017	29 June–17 August 2017	23	14,800
Winter 2018	18 January–14 March 2018	19	8,158
Fall 2018	12 October–28 November 2018	22	11,506
Total	-	64	34,464

Table 6. Number of groups and individuals of marine mammals observed during GoMMAPPS 2017–2018 aerial surveys

Unid = unidentified

Common Name	Species	Summer 2017, groups	Summer 2017, individuals	Winter 2018, groups	Winter 2018, individuals	Fall 2018, groups	Fall 2018, individuals
Common bottlenose dolphin	<i>Tursiops truncatus</i>	261	1,990	195	1,558	346	1,762
Atlantic spotted dolphin	<i>Stenella frontalis</i>	19	274	4	120	2	44
Bottlenose/Atlantic spotted dolphin	<i>Tursiops truncatus/Stenella frontalis</i>	6	49	0	0	4	31
Rough-toothed dolphin	<i>Steno bredanensis</i>	1	12	0	0	0	0
<i>Stenella</i> spp.	<i>Stenella</i> spp.	1	8	0	0	0	0
Unid. dolphin	unid. dolphin	1	1	1	3	1	8
Manatee	<i>Trichechus manatus</i>	4	5	1	1	0	0
Total	-	293	2,339	201	1,682	353	1,845

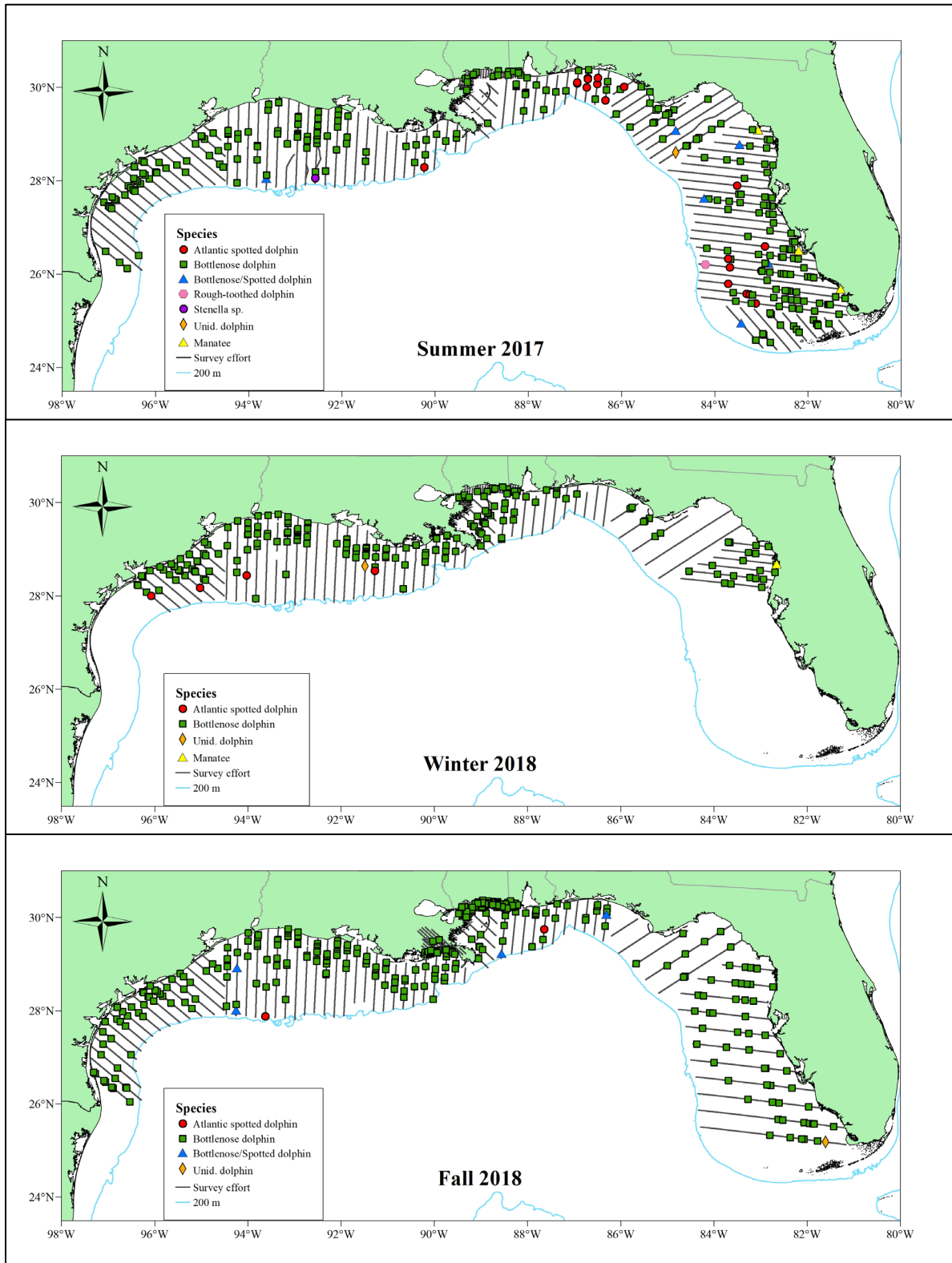

Figure 13. Locations of marine mammal sightings during GoMMAPPS aerial surveys.

A total of 2,050 sea turtle sightings, including over 2,300 individuals, were recorded across the three aerial surveys. Loggerhead turtles, Kemp’s ridley, leatherback, and green turtles were observed during all surveys but nearly 50% of sightings could not be identified to species, because many were seen below the surface or too far from the trackline (Table 7, Figure 14).

Table 7. Number of groups and individuals of sea turtles observed during GoMMAPPS aerial surveys

Unid = unidentified

Common Name	Species	Summer 2017, groups	Summer 2017, individuals	Winter 2018, groups	Winter 2018, individuals	Fall 2018, groups	Fall 2018, individuals
Green sea turtle	<i>Chelonia mydas</i>	21	21	2	2	1	1
Kemp's ridley	<i>Lepidochelys kempii</i>	111	113	231	249	83	83
Leatherback	<i>Dermochelys coriacea</i>	36	37	7	7	5	5
Loggerhead	<i>Caretta caretta</i>	290	299	139	145	112	112
Unid. hardshell	Unid. hardshell	430	492	450	606	132	137
Total	-	888	962	829	1009	333	338

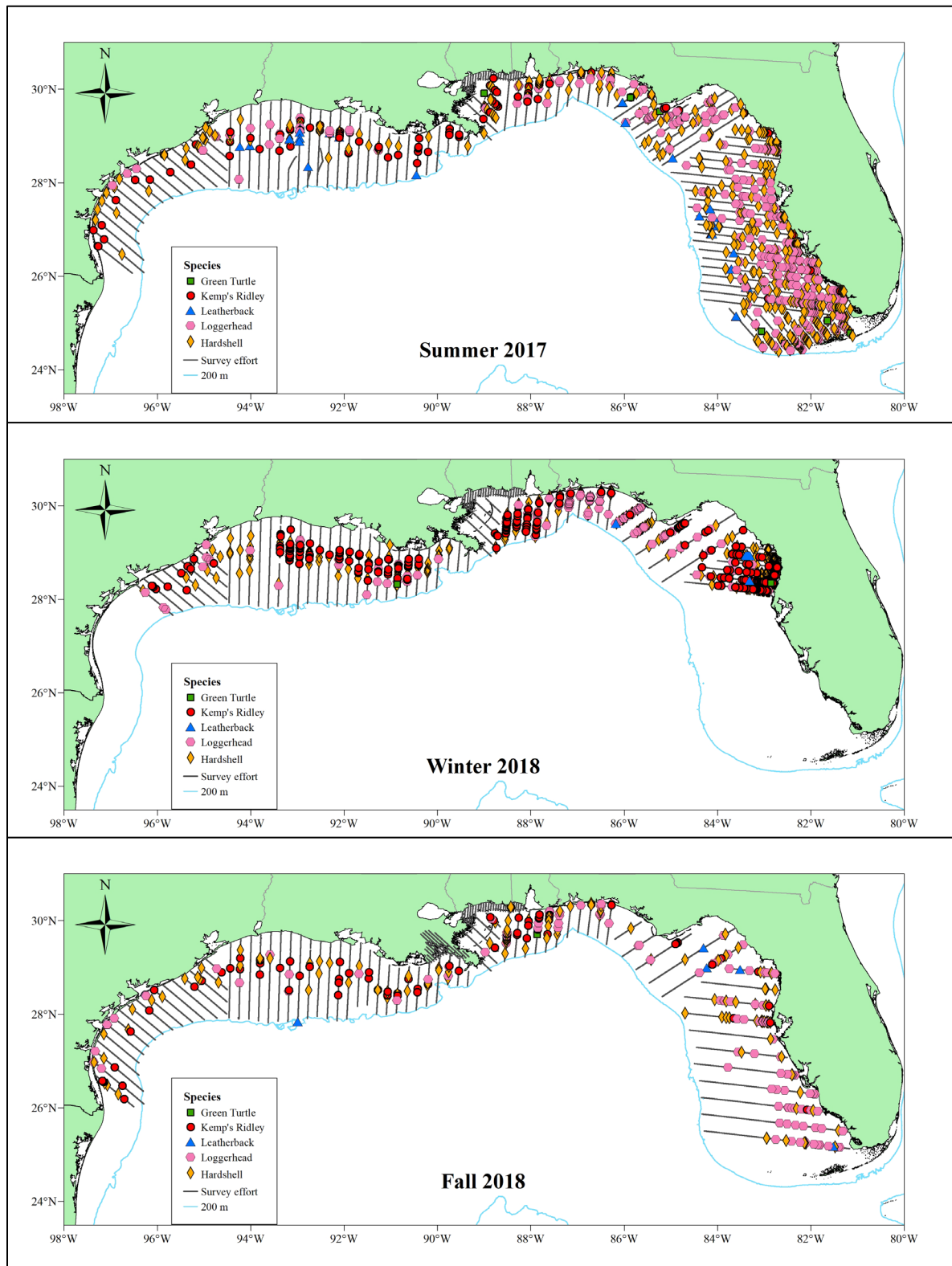

Figure 14. Locations of sea turtle sightings during GoMMAPPS aerial surveys.

Opportunistic fish species sightings primarily included unidentified sharks, hammerhead sharks (*Sphyrnidae* spp.), unidentified rays, manta rays (*Manta* spp.), and whale sharks (*Rhincodon typus*) (Table 8).

Table 8. Number of groups and individuals of fish observed by Team 1 during GoMMAPPS aerial surveys

Unid = unidentified

Common Name	Species	Summer 2017, groups	Summer 2017, individuals	Winter 2018, groups	Winter 2018, individuals	Fall 2018, groups	Fall 2018, individuals
Hammerhead shark	<i>Sphyrnidae</i> spp.	43	43	13	13	52	52
Manta ray	<i>Manta</i> spp.	4	4	38	44	27	29
Sunfish	<i>Mola mola</i>	0	0	0	0	1	1
Whale shark	<i>Rhincodon typus</i>	5	22	0	0	2	2
Unid. large fish	Unid. large fish	0	0	0	0	1	1
Unid. Ray	Unid. ray	36	46	2	2	23	30
Unid. Shark	Unid. shark	254	301	65	229	351	439
Total	-	342	416	118	288	457	554

3.2 Broad-scale Vessel Surveys

3.2.1 Field Operations

3.2.1.1 Marine Mammal Visual Surveys

The three GoMMAPPS vessel surveys resulted in 19,576 km of trackline visually surveyed on effort (Table 9). There were 709 marine mammal groups sighted, on- or off-effort, from 19 confirmed species, not including unidentified taxa (Table 10, Figure 15). A diverse suite of oceanic dolphin and small whale species were encountered including pantropical spotted dolphins, Risso’s dolphins, pygmy or dwarf sperm whales, rough-toothed dolphins, short-finned pilot whales, and beaked whales (Ziphiidae). Large whale sightings included sperm whales and Rice’s whales. Continental shelf species included common bottlenose dolphins and Atlantic spotted dolphins.

Table 9. Summary of 2017–2018 GoMMAPPS vessel survey effort

Survey	Vessel	Dates	Days at sea	Effort (km)
GU17-03	<i>Gordon Gunter</i>	2 July–25 August 2017	49	7,289
GU18-01	<i>Gordon Gunter</i>	14 January–16 March 2018	55	5,814
PC18-05	<i>Pisces</i>	11 August–6 October 2018	51	6,473
Total	-	-	155	19,576

Table 10. Number of groups and individuals of marine mammals sighted during 2017–2018 GoMMAPPS vessel surveys

Counts include on- and off-effort sightings. Categories with multiple species indicate ambiguity in species identification. Unid = unidentified.

Common Name	Species	Summer 2017, groups	Summer 2017, individuals	Winter 2018, groups	Winter 2018, individuals	Summer/Fall 2018, groups	Summer/Fall 2018, individuals
Rice's whale	<i>Balaenoptera ricei</i>	3	9	1	9	0	0
Sei/Rice's whale	<i>Balaenoptera borealis/ricei</i>	0	0	1	1	0	0
Sei/Rice's/Fin whale	<i>Balaenoptera borealis/ricei/physalus</i>	0	0	0	0	2	2
Sperm whale	<i>Physeter macrocephalus</i>	60	105	18	26	81	144
Dwarf sperm whale	<i>Kogia sima</i>	0	0	0	0	1	3
Pygmy/Dwarf sperm whale	<i>Kogia</i> spp.	14	28	0	0	17	30
Cuvier's beaked whale	<i>Ziphius cavirostris</i>	3	4	3	6	1	2
Gervais' beaked whale	<i>Mesoplodon europaeus</i>	0	0	0	0	1	4
Unid. Ziphiid	unid. Ziphiid	7	15	2	4	7	22
Unid. Mesoplodont	<i>Mesoplodon</i> spp.	4	11	1	1	4	8
Short-finned pilot whale	<i>Globicephala macrorhynchus</i>	8	50	1	16	3	31
Killer whale	<i>Orcinus orca</i>	1	2	0	0	2	11
False killer whale	<i>Pseudorca crassidens</i>	1	27	0	0	0	0
Pygmy killer whale	<i>Feresa attenuata</i>	1	9	0	0	0	0
Melon-headed whale	<i>Peponocephala electra</i>	4	144	2	89	0	0
Melon-headed/Pygmy killer whale	<i>Peponocephala/Feresa</i>	2	11	0	0	0	0
Melon-headed/Pygmy killer/False killer whale	<i>Peponocephala/Feresa/Pseudorca</i>	0	0	0	0	2	7
Bottlenose dolphin	<i>Tursiops truncatus</i>	34	429	30	298	15	134
Atlantic spotted dolphin	<i>Stenella frontalis</i>	7	210	6	176	11	198
Bottlenose/Atlantic spotted dolphin	<i>Tursiops truncatus/Stenella frontalis</i>	2	20	1	5	3	68
Risso's dolphin	<i>Grampus griseus</i>	11	94	5	47	1	12

Common Name	Species	Summer 2017, groups	Summer 2017, individuals	Winter 2018, groups	Winter 2018, individuals	Summer/Fall 2018, groups	Summer/Fall 2018, individuals
Rough-toothed dolphin	<i>Steno bredanensis</i>	0	0	3	36	0	0
Fraser's dolphin	<i>Lagenodelphis hosei</i>	1	16	0	0	0	0
Pantropical spotted dolphin	<i>Stenella attenuata</i>	24	709	17	875	20	607
Striped dolphin	<i>Stenella coeruleoalba</i>	0	0	2	58	1	63
Clymene dolphin	<i>Stenella clymene</i>	1	38	3	26	1	2
Spinner dolphin	<i>Stenella longirostris</i>	2	90	0	0	0	0
<i>Stenella</i> spp.	<i>Stenella</i> spp.	28	542	14	266	16	324
Unid. odontocete	unid. odontocete	24	63	3	8	15	73
Unid. small whale	unid. small whale	4	12	0	0	0	0
Unid. large whale	unid. large whale	7	9	1	1	5	9
Unid. dolphin	unid. dolphin	59	697	29	226	53	865
Total	-	310*	3,344	141*	2,174	258*	2,619

*Total number of groups per survey does not equal sum of species observed as some sightings were mixed species.

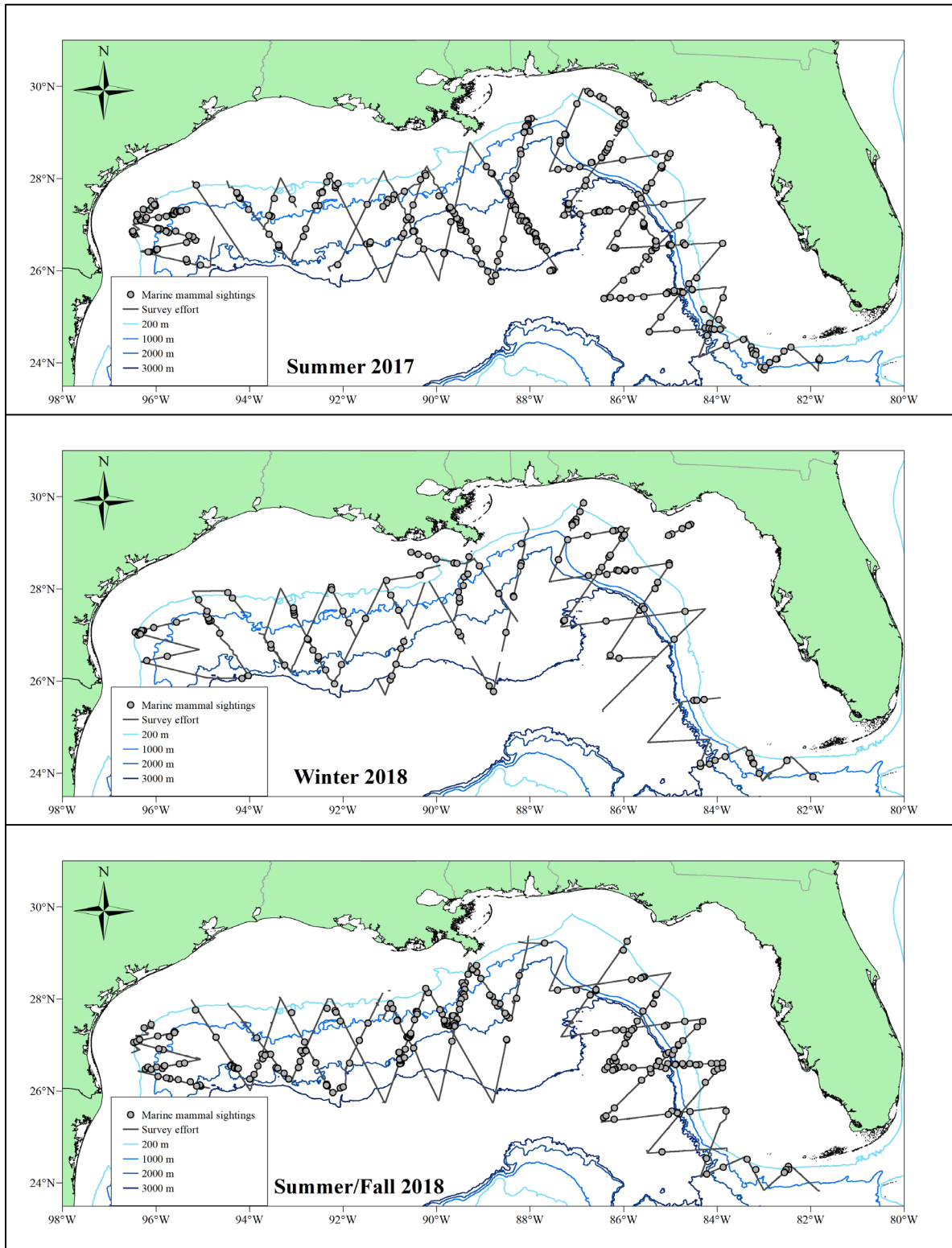

Figure 15. Locations of marine mammal sightings during GoMMAPPS vessel surveys.

Notable sightings included a single Rice’s whale sighted in the western GOM during the summer 2017 survey. Though there are a few sightings of either Rice’s or sei whales reported in the western GOM during the 1990s, there has not been a verified sighting of Rice’s whales in the western GOM. Another notable sighting was a group of killer whales (*Orcinus orca*) during the summer 2017 survey, in which photographs of certain individuals were matched to photo-identification records from previous sightings in the GOM in 2001 (SEFSC, unpublished data).

3.2.1.2 Marine Mammal Biopsy Sampling

Two biopsy samples were collected opportunistically during the summer 2017 vessel survey, both from Rice’s whales. They were subsampled for future analyses including genetics (skin stored in DMSO), stable isotopes (skin frozen at -80°C), and contaminants (blubber frozen at -80°C). Subsequent genetic sequencing confirmed the species identification in the field.

3.2.1.3 Passive Acoustic Survey

3.2.1.3.1 Towed Array

During the three GoMMAPPS vessel surveys, we recorded over 1,360 hours of acoustic data from the towed array yielding more than 19 TB of data and 1,140 cetacean detections. During real-time monitoring, we broadly categorized acoustic detections as Risso’s dolphin clicks, sperm whale clicks, dwarf/pygmy sperm whale (*Kogiidae*) clicks, beaked whale (*Ziphiidae*) clicks, dolphin (*Delphinidae*) vocalizations (whistles only, or whistles and clicks), or odontocete (suborder *Odontoceti*) clicks (Table 11, Figure 16). Over the three surveys, real-time acoustic detections include 18 Risso’s dolphin encounters, 313 sperm whale encounters, 16 dwarf/pygmy sperm whale encounters, and 52 beaked whale encounters. An additional three missed dwarf and/or pygmy sperm whale species encounters were detected in preliminary post-processing of the winter 2018 data. Real-time sperm whale encounters may represent either individuals or groups of individuals. Additional odontocete encounters may be identified as beaked whale encounters in post-processing. Acoustic detections of odontocetes that were not identifiable at the species level were made throughout the survey and were correlated with visual sightings when localization was possible. These recordings with visually-verified species identifications will be reanalyzed and verified in post processing to develop acoustic species classification algorithms for acoustic species identification. Acoustic data from sperm whales are used to estimate passive-acoustic-based density and abundance, and data from beaked whales will be used to improve estimates of beaked whale abundance in the future.

Table 11. Summary of towed hydrophone array data and detections and sonobuoy data collected during the 2017–2018 GoMMAPPS cruises

Towed array detections represent acoustic encounters, either individuals or groups. Sonobuoy detections represent calls that may be produced by one or more individuals.

Year	Hours of Towed Array Recordings	Real-time Towed Array Group Detections	Sonobuoy Deployments - Successful (Total)	Hours of Sonobuoy Recordings	Post-processing Sonobuoy Detections - Calls (sonobuoys)
2017 summer	481	545	25 (33)	133	354 (5)
2018 winter	393	198	-	-	-
2018 summer/fall	493	399	33 (37)	76	31 (4)
Total	1,367	1,142	58 (70)	209	385 (9)

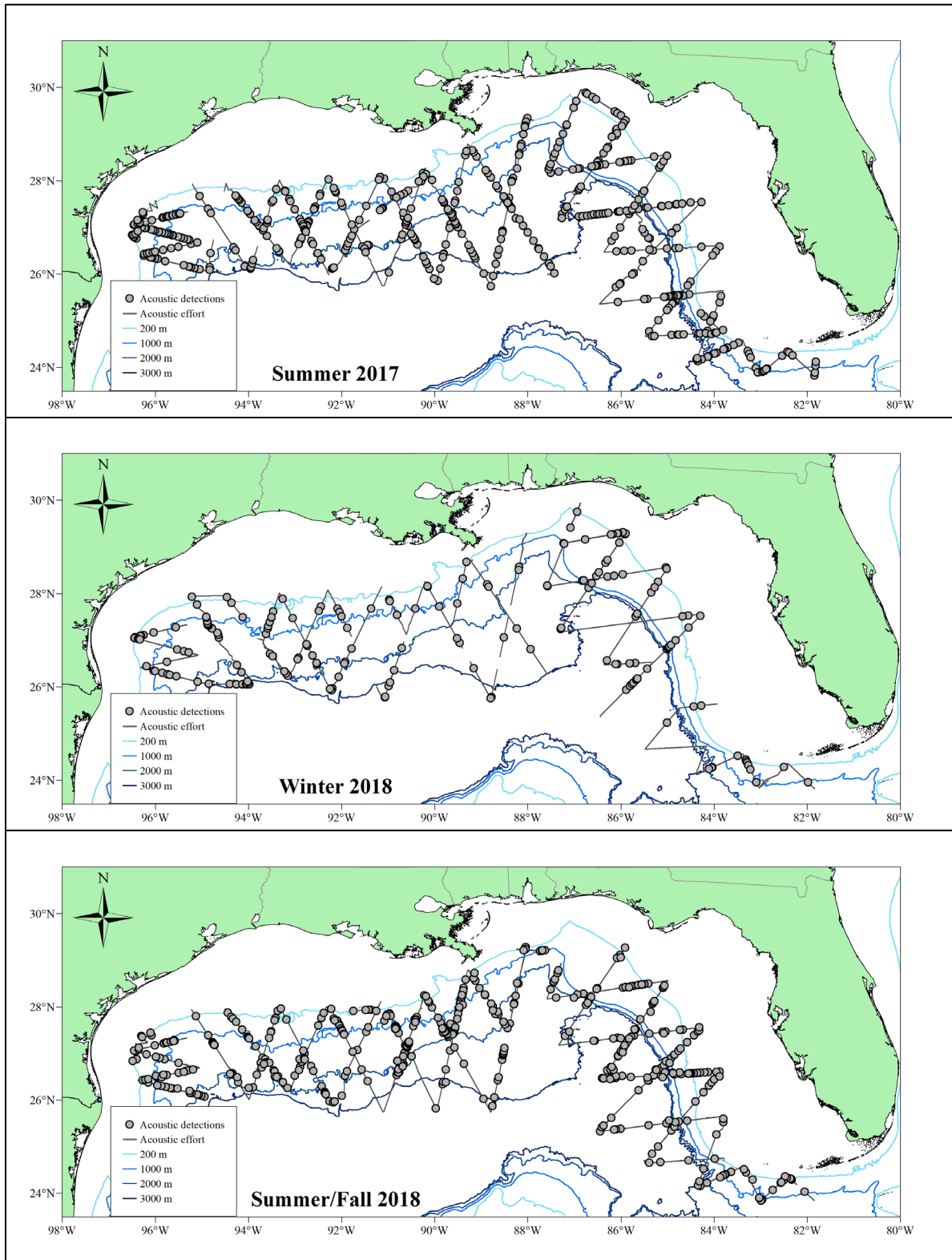

Figure 16. Real-time acoustic detections from the towed array.

3.2.1.3.2 Sonobuoys

Over the course of the summer 2017 and summer-fall 2018 vessel surveys, we deployed 70 sonobuoys, of which 58 successfully transmitted a signal and yielded 209 hours of recordings. During the summer 2017 survey, we deployed 28 sonobuoys at predetermined stations, and five were deployed opportunistically in the presence of baleen whale sightings. Two sets of stations were close enough to be recorded as pairs and two of the opportunistic buoys were close enough to stations for paired recordings. Over 350 Rice's whale calls, including long-moans, downsweep pulse sequences, and tonal sequences, were detected, with detections on both sonobuoys from two of the sonobuoy pairs, and on one additional sonobuoy (Table 11, Figure 17). Calls detected on both sonobuoys from the pairs will be further analyzed to obtain localizations and provide information on call rates of calling whales and potentially on numbers of whales detected. No calls were detected on sonobuoys deployed in the presence of the whale biopsied in the western GOM. During the summer-fall 2018 survey, we deployed 35 sonobuoys at 32 predetermined stations; 28 stations were on the main tracklines, and four stations were on the fine-scale western GOM lines. We deployed two sonobuoys opportunistically in the presence of baleen whale sightings. Each of the opportunistic buoys were close enough to a station buoy to potentially allow paired-buoy localizations. A total of 31 Rice's whale calls, including long-moans and downsweep pulse sequences, were detected on four of the sonobuoys, two of which were paired (Table 11, Figure 18). Approximately five calls may be localizable from this sonobuoy pair, and these data will be further analyzed to evaluate number of individuals and call rates.

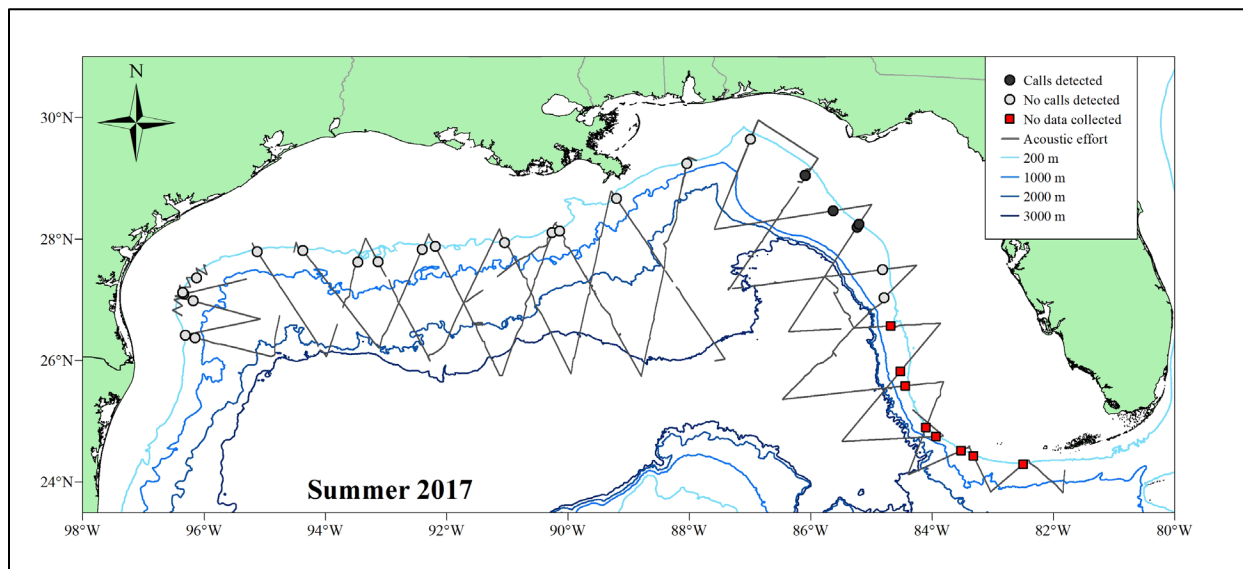

Figure 17. Locations of sonobuoy deployments during GU17-03.

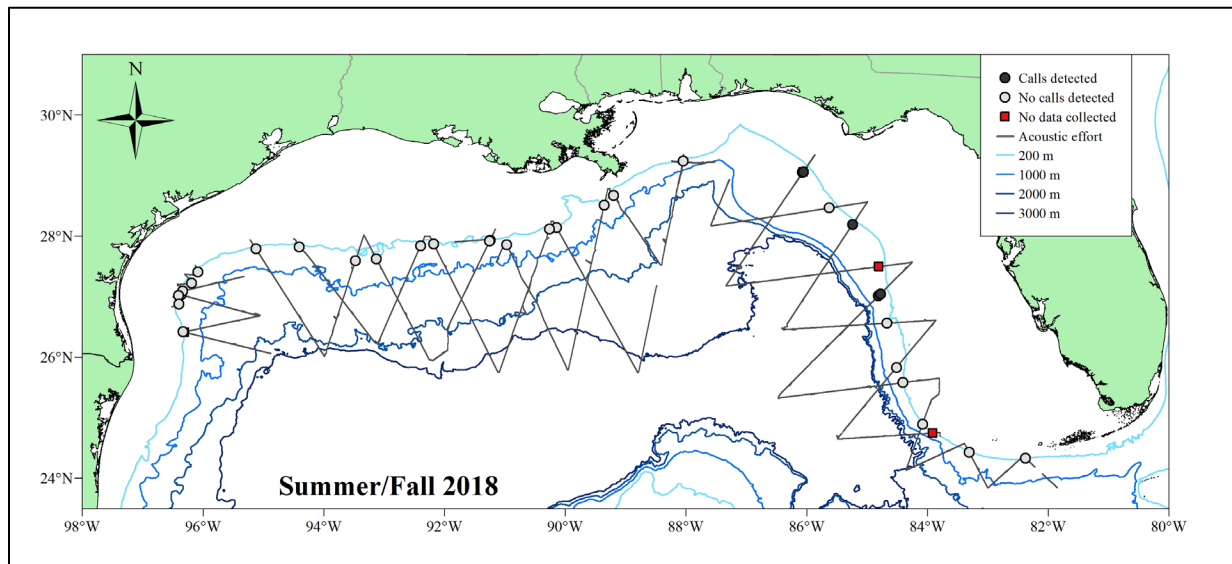

Figure 18. Locations of sonobuoy deployments during PC18-05.

3.2.1.4 Plankton Sampling

From 136 plankton tows, scientists from the SEFSC Early Life History lab examined 2,554 larval fish on board, including the following taxa: snapper (Lutjanidae), grouper (Serranidae), billfish (Istiophoridae, Xiphiidae), tuna (Scombridae), and lionfish (Pterois spp.). They visually identified 11 larvae as Atlantic bluefin tuna (*Thunnus thynnus*), which were sent to a genetic laboratory for DNA analysis. In addition, the scientists extracted their otoliths to examine larval growth rate patterns for Bluefin tuna larvae collected outside of the peak spawning time frame (May–June).

As of this report, 17,132 sampled fish have been identified from 55 plankton stations representing 75 fish families and at least 40 species (Table 12). The most abundant fish family was the myctophids represented by eight species, followed by gonostomatids. In addition, tunas (Scombridae) followed in third place and were represented by at least five species. Finally, two reef fish families (Gobiidae and Labridae) were the fourth and fifth most abundant, respectively. They also found several families with multiple species represented, including six species of groupers (Serranidae), four species of clupeids, six species of carangids, and seven species of gypsalids. The samples have been archived and are awaiting resources for further analysis.

Table 12. Fish abundance by family during summer 2017 (GU17-03)

Family name	Abundance
Acanthuridae	20
Acropomatidae	2
Albulidae	1
Anguillidae	3
Apogonidae	50
Ariommatidae	4
Balistidae	60
Bothidae	635

Family name	Abundance
Bramidae	5
Bregmacerotidae	400
Callionymidae	26
Caproidae	27
Carangidae	971
Ceratioidei	26
Cetomimidae	2
Chaetodontidae	10
Chiasmodontidae	2
Chlorophthalmidae	88
Cirrhitidae	2
Clupeidae	45
Congridae	255
Coryphaenidae	59
Cynoglossidae	32
Dactylopteridae	3
Echeneidae	13
Engraulidae	206
Exocoetidae	18
Gempylidae	154
Gerreidae	12
Gobiesocidae	1
Gobiidae	1424
Gonostomatidae	2200
Haemulidae	18
Hemiramphidae	7
Holocentridae	31
Istiophoridae	37
Kyphosidae	4
Labridae	1146
Lophiidae	4
Lophiiformes	2
Lutjanidae	158
Malacanthidae	4
Megalopidae	12
Microdesmidae	22
Monacanthidae	17
Mullidae	8
Muraenidae	26

Family name	Abundance
Myctophidae	3891
Nemichthyidae	2
Neoscopelidae	3
Nettastomatidae	1
Nomeidae	748
Notosudidae	7
Ophichthidae	56
Ophidiidae	27
Ostraciidae	1
Paralepididae	161
Paralichthyidae	276
Phosichthyidae	15
Pomacanthidae	13
Pomacentridae	65
Priacanthidae	81
Scaridae	541
Scombridae	2182
Scombrobracidae	1
Scorpaenidae	114
Serranidae	228
Sparidae	2
Sphyraenidae	197
Stomiidae	7
Stromateidae	1
Synodontidae	107
Tetraodontidae	7
Trichiuridae	2
Triglidae	1
Unidentified or damaged	143
Total abundance (not final)	17,132

3.3 Abundance Estimation

Abundance estimates were derived separately for the aerial and vessel surveys. The Atlantic spotted dolphin stock is the only stock to commonly cross between continental shelf and oceanic waters in the NGOM (Fulling et al. 2003; Maze-Foley and Mullin 2006). A combined abundance estimate for Atlantic spotted dolphins can be found in the 2021 SARS (Hayes et al. 2022).

3.3.1 Broad-scale Aerial Surveys—Bottlenose and Atlantic Spotted Dolphins

Table 5 in Garrison et al. (2021) shows the selected models for each seasonal survey and associated estimates of detection probability for dolphins. The models generally fit the data well as indicated by the Cramer von-Mises GOF tests. There was a decline in the number of sightings detected near the trackline in some of the seasonal surveys. Left-truncation of the data was explored; however, this approach did not improve the model fit and resulted in much higher and less certain estimates of abundance. Plots showing the detection probability models and associated fits for each survey are shown in Garrison et al. (2021), Figures 6–8. The detection probability on the trackline ranged from 0.657 to 0.801 across the surveys. The overall detection probability in the survey strip ranged from 0.532 to 0.674 (Garrison et al. 2021, Table 5).

Abundance estimates and associated variance were derived for each surveyed bottlenose dolphin stock (Table 13). The abundance estimates for the Eastern Coastal, Western Coastal, and Continental Shelf stocks from the winter survey should be interpreted with caution since the strata were not completely surveyed in this season. For the Mississippi Sound stock, the fall abundance estimate was notably higher than the other two seasonal surveys. For the Atlantic spotted dolphin stock, there was a large difference in the summer and fall abundance estimates associated with the low number of sightings during the fall in the eastern GOM (Table 13).

Table 13. Bottlenose and Atlantic spotted dolphin abundance estimates (CV) within stock areas from seasonal aerial surveys

The best estimate is the inverse variance weighted average of the seasonal estimates. For the Eastern Coastal, Shelf, and Western Coastal stocks, the best estimate only includes the summer and fall estimates due to incomplete coverage in winter months. The Atlantic spotted dolphin best estimate only includes the summer estimates.

Stock	Summer	Winter	Fall	Best Estimate
Mississippi Sound	2,145 (0.337)	1,265 (0.353)	4,337 (0.159)	3,078 (0.135)
Eastern Coastal	11,482 (0.232)	27,597 (0.401)	21,386 (0.235)	16,407 (0.173)
Northern Coastal	4,670 (0.493)	18,194 (0.240)	7,152 (0.318)	11,543 (0.186)
Western Coastal	18,600 (0.301)	58,542 (0.184)	21,765 (0.140)	20,759 (0.132)
Continental Shelf	74,959 (0.149)	58,349 (0.229)	52,090 (0.143)	63,280 (0.105)
Atlantic spotted dolphin	15,929 (0.315)	16,146 (0.559)	2,529 (0.713)	15,929 (0.315)

The best abundance estimates for each stock are shown in Table 14. For the Coastal and Continental Shelf stocks, the abundance estimate is the inverse-variance weighted average of the valid seasonal abundance estimates. For the MSS and MRD estuarine stocks, the best abundance estimate is intended to represent the resident animals. Therefore, the winter estimate was used for these stocks as it presumably reflects animals that are most likely to be present year-round.

Comparisons between abundance estimates from the 2017–2018 surveys for specific stocks to those from similar surveys conducted in 2011–2012 are shown in Table 14. Abundance estimates for bottlenose dolphin Continental Shelf, Northern Coastal, and Eastern Coastal stocks were significantly higher than those from the 2011–2012 surveys at the $\alpha = 0.10$ level. While the relatively high uncertainty in the abundance estimates limits the power of these comparisons, the available estimates suggest possible increases in abundance for these stocks over the 6-year period between the surveys.

Table 14. Comparison of abundance estimates for bottlenose dolphin stocks and for Atlantic spotted dolphins from the 2011–2012 aerial surveys to the 2017–2018 aerial surveys and tests of significant pairwise differences at alpha = 0.10

Stock	2011–2012 Abundance (CV)	2011–2012 Abundance 95% Confidence Interval	2017–2018 Abundance (CV)	2017–2018 Abundance 95% Confidence Interval	z-test for difference of log-transformed means p-value
Eastern Coastal	12,180 (0.144)	9,200–16,126	16,407 (0.173)	11,720–22,967	0.091†
Northern Coastal	7,569 (0.221)	4,936–11,604	11,543 (0.186)	8,038–16,576	0.070†
Western Coastal	19,381 (0.200)	13,148–28,568	20,759 (0.132)	16,047–26,852	0.386
Continental Shelf	48,060 (0.113)	38,540–59,931	63,280 (0.105)	51,493–77,764	0.037†
MSS	1,104 (0.591)	377–3,226	1,265 (0.353)	646–2,476	0.416
MRD*	332 (0.933)	70–1,565	1,446 (0.186)	1,007–2,075	NA
Atlantic spotted dolphin**	12,274 (0.434)	5,585–28,997	15,929 (0.315)	8,717–29,107	0.307

*The MRD estimate is that reported in Garrison (2017). No comparison was made with the 2017-2018 estimate because the region was not surveyed during winter 2018.

**The Atlantic spotted dolphin comparisons are for the summer estimates, whereas the others are averages across seasons.

† indicates significant differences between estimates

3.3.2 Broad-scale Aerial Surveys–Sea Turtles

The selected MRDS models for each sea turtle taxon are shown in Table 15. The MRDS models had a good fit as indicated by the Cramer von-Mises GOF tests (Table 15). Each model included the interaction term including observer station indicating differences in the detection probability on the trackline between the two survey teams. Turtle detection probability on the trackline (for both survey teams combined) ranged from 0.384 to 0.771 across the taxa.

Table 15. Model parameters for turtle Mark-Recapture Distance Sampling model for each sea turtle species

The selected explanatory variables for each model are shown: distance = distance from trackline, observer = observer team, cc = cloud cover, ss = sea state, tb = turbidity, sp = sun penetration. ~1 indicates a null model including no explanatory factors selected. The probability of detection on the trackline is for both survey teams combined.

Species	Mark-Recapture Model (mr)	Distance Model (ds)	Detection probability on the trackline [p(0)] (CV)	Detection probability within survey strip (pds) (CV)	Cramer von-Mises GOF Test p-value
Leatherback	~ distance * observer + tb	~ ss	0.679 (0.127)	0.588 (0.082)	0.839
Green turtle	~ distance * observer + ss, + tb	~ sp	0.530 (0.225)	0.610 (0.061)	0.844
Kemp's ridley	~ distance * observer + cc + tb	~1	0.686 (0.057)	0.463 (0.026)	0.261
Loggerhead	~ distance * observer + ss + cc + sp	~ ss + sp	0.771 (0.029)	0.493 (0.020)	0.160
Hardshell	~ distance * observer + sp + tb	~ ss + sp	0.384 (0.078)	0.560 (0.025)	0.207

Abundance estimates for each taxon are shown in Table 16. These estimates include corrections for the availability of turtles at the surface based upon the environmental conditions at the time of the observations for loggerhead, Kemp's ridley, green, and unidentified hardshell turtles. For leatherback turtles, the average correction of 0.407 was used based on an average from available telemetry tag data (see Garrison et al. 2022 for details). The estimates for green turtles should be interpreted with caution, particularly for the winter and fall 2018 surveys when the habitat north of the Florida Keys was not surveyed. This likely results in an underestimate of total green turtle abundance. Seasonal and inter-annual variability in sea turtle abundance are discussed in Garrison et al. (2022).

Table 16. Sea turtle abundance estimates (CV) from seasonal aerial surveys including the inverse-variance weighted average of seasonal estimates

Species	Summer	Winter	Fall	Weighted Average
Leatherback	8,092 (0.312)	1,869 (0.741)	1,634 (0.466)	4,770 (0.265)
Green turtle	4,448 (0.410)	1,038 (0.734)	237 (1.024)	3,658 (0.366)
Kemp's ridley	42,743 (0.168)	108,494 (0.180)	44,100 (0.178)	64,517 (0.113)
Loggerhead	73,248 (0.122)	106,318 (0.194)	32,489 (0.174)	69,908 (0.100)
Hardshell	206,028 (0.148)	339,717 (0.198)	99,586 (0.239)	220,400 (0.116)

This analysis accounted for major known sources of bias in the estimation of sea turtle abundance based on aerial line-transect surveys associated with estimating detection probability on the trackline and the probability that animals are at the surface. However, these corrections do not account for turtles that may be present within the surveyed area but are too small to be reliably detected by visual surveyors. Limited studies suggest that turtles <30 cm in total length are unlikely to be detected by aerial observers. The abundance of smaller juveniles is not reflected in these estimates. The remaining major source of uncertainty is the difficulty in identifying sea turtles from the air, resulting in large numbers of unidentified hardshell turtle sightings. In most seasons and surveys, unidentified turtles are the largest

category of sightings. In addition, species identification errors may occur, particularly when attempting to distinguish between green and loggerhead turtles that are beneath the surface. In this analysis, we have estimated the abundance of unidentified hardshell turtles separately from the identified species. It is likely that the species composition of these sightings varies both seasonally and spatially. Therefore, habitat-based spatial models are required to partition these sightings and therefore account for them when considering the abundance of each species.

3.3.3 Broad-scale Vessel Surveys

3.3.3.1 Visual Survey Abundance Results

3.3.3.1.1 Summer 2017

For the summer 2017 survey, within the defined strata, we based the abundance estimates on a total of 5,014 km of trackline surveyed on effort by both teams and 563 km of effort with only the flying bridge team (Team 1) active (Figure 9). While on effort, one or both teams sighted 251 unique marine mammal groups (Garrison et al. 2020, Table 1, Figures 2–5).

The selected models for the detection functions for each taxonomic group provided adequate fits to the data as indicated by non-significant (p -value > 0.05) GOF tests (Garrison et al. 2020, Table 2). Notably, we found no apparent effect of distance (or other factors) in the mark-recapture component of the large whale and small whale mark-recapture model, and no evidence of a decline in re-sight rates with increasing distance from the trackline for these taxa. Detection functions for each group are shown in Garrison et al. 2020, Figures 6–9. The small sample size in the “cryptic” species results in an unreliable model fit and detection function (Garrison et al. 2020, Figure 9).

Abundance estimates for each species are shown in Table 17. In each case, the abundance estimates include the apportioned unidentified taxa relevant for each species. For species seen only during the period when only Team 1 was on effort, we derived the abundance estimates using a single observer model for Team 1, and applied the estimated detection probability on the trackline. The abundance estimates for the deep-diving species (beaked whales and sperm whales) are significantly negatively biased due to their long dive times and resulting low availability to visual observers. The uncertainty around all abundance estimates is relatively high, with the best CVs ranging between 0.27–0.41 for the more common species. Rare species with a smaller number of sightings had higher CVs that exceeded 0.9 (Table 17). The majority of this variability was associated with variation in encounter rates among different tracklines rather than variation in group sizes or uncertainty in the detection function.

3.3.3.1.2 Summer-Fall 2018

For the summer-fall 2018 survey, we based the abundance estimates on a total 5,205 km of trackline surveyed on effort by both teams within the defined strata (Figure 9). While on effort, one or both teams sighted 215 marine mammal groups (Garrison et al. 2020, Table 4, Figures 11–14). These sightings included 76 on-effort sperm whale sightings (Garrison et al. 2020, Figure 11). Two sightings of baleen whales within the primary Rice’s whale (GOM Bryde’s whale) habitat occurred, but the vessel did not approach closely enough for observers to confirm the species identification (Garrison et al. 2020, Figure 11). We classified these sightings as Rice’s whales for abundance estimation. The most common identified oceanic dolphin was pantropical spotted dolphins, but observers recorded few sightings of other stenellid species during the survey (Garrison et al. 2020, Figure 12). Observers also recorded relatively few sightings of small whales throughout the survey with only a small number of identified Risso’s dolphins and short-finned pilot whales (Garrison et al. 2020, Figure 13). Observers detected two groups of killer whales, including one in the northern portion of the survey area near the shelf break (Garrison et

al. 2020, Figure 13), and a small number of “cryptic” species, including pygmy and/or dwarf sperm whales and beaked whales in deep water during the survey (Garrison et al. 2020, Figure 14).

The selected models for the detection functions for each taxonomic group provided adequate fits to the data as indicated by non-significant (p -value > 0.05) GOF tests (Garrison et al. 2020, Table 5). As with the 2017 survey, we found no apparent effect of distance (or other factors) in the mark-recapture component of the large whale and small whale mark-recapture model, and no evidence of a decline in re-sight rates with increasing distance from the trackline for these taxa. Detection functions for each group are shown in Garrison et al. 2020, Figures 15–18. For both dolphins and small whales, there is a rapid decline in sighting rates with increasing distance from the trackline (Garrison et al. 2020, Figures 16–17). This exponential increase near the trackline suggests difficulty in visualizing groups further away from the line during this survey. The shape of the function results in a low estimated probability of detection within the surveyed strip and high uncertainty (Garrison et al. 2020, Table 5). The small sample size in the “cryptic” species results in an unreliable model fit and detection function (Garrison et al. 2020, Figure 18).

Abundance estimates for each species from the summer-fall 2018 survey are shown in Table 17. In each case, the abundance estimates include the apportioned unidentified taxa relevant for each species. To account for the low number of small whales identified to species during the 2018 survey, we used the relative density in each stratum from the summer 2017 survey to partition unidentified odontocetes and unidentified small whales among the potential species. The abundance estimates for the deep-diving species (beaked whales and sperm whales) are significantly negatively biased due to their long dive times and resulting low availability to visual observers. The uncertainty around all abundance estimates is relatively high, with the best CVs ranging between 0.32–0.46 for the more common species. Rare species with a smaller number of sightings had higher CVs that exceeded 0.9 (Table 17). This high uncertainty was associated with variation in encounter rates among different tracklines and uncertainty in the detection function estimation for the dolphin and small whale groups.

Table 17. Abundance estimates (CV) from previous year large vessel cruises and GoMMAPPS summer 2017 and summer/fall 2018 surveys

Species	2003	2004	2009	2017	2018
Sperm whale	2,542 (0.336)	1,686 (0.405)	2,096 (0.546)	1,078 (0.293)	1,307 (0.326)
Rice's whale*	0	64 (0.880)	100 (1.030)	84 (0.924)	40 (0.547)
Bottlenose dolphin	21,350 (0.472)	8,864 (0.504)	9,640 (0.659)	8,756 (0.412)	5,833 (0.462)
Pantropical spotted dolphin	72,901 (0.198)	78,878 (0.410)	84,047 (0.363)	27,362 (0.274)	58,725 (0.405)
Spinner dolphin	5,160 (0.551)	24,535 (0.584)	19,678 (0.531)	5,982 (0.540)	0
Striped dolphin	5,494 (0.427)	10,764 (0.510)	3,060 (0.727)	0	3,633 (0.558)
Atlantic spotted dolphin	0	0	1,161 (1.021)	3,267 (0.521)	8,178 (0.553)
Fraser's dolphin	0	0	0	427 (1.028)	0
Clymene dolphin	10,899 (0.415)	13,257 (0.808)	1,319 (0.782)	1,026 (1.033)	0
Rough-toothed dolphin	9,253 (0.785)	0	3,509 (0.668)	0	0
Risso's dolphin	4,471 (0.471)	4,641 (0.856)	7,788 (0.672)	2,998 (0.521)	632 (0.596)
Short-finned pilot whales	2,740 (0.519)	587 (0.884)	4,788 (0.738)	1,274 (0.539)	1,402 (0.711)
False killer whale	1,293 (0.635)	0	0	1,069 (0.973)	162 (0.741)
Killer whale	0	198 (1.002)	52 (0.968)	86 (0.874)	450 (0.878)
Melon-headed whale	1,502 (0.957)	7,351 (0.871)	4,188 (0.757)	2,694 (0.760)	454 (0.889)
Pygmy killer whale	501 (0.739)	490 (0.871)	359 (0.955)	1,227 (1.149)	0
All Ziphiids**	573 (0.435)	55 (0.719)	276 (0.588)	316 (0.278)	193 (0.650)
Pygmy or dwarf sperm whale**	441 (0.424)	38 (0.711)	124 (0.604)	293 (0.593)	360 (0.424)

*The abundance estimate for Rice's whales is not corrected for p(0), uses a detection function derived from all available Rice's whale or baleen whale sightings from 2003-2019, and survey effort in the core habitat area.

**Cryptic species estimates are not corrected for detection probability on the trackline.

3.3.3.2 Passive Acoustic Sperm Whale Localization, Density and Abundance Results

Over the three seasonal surveys, over 18,000 km were transited on-effort in the three oceanic strata, with a total best estimate of 630 sperm whale click train events detected on-effort from 149 sperm whale groups (Table 18, Figure 19). An additional 53 sperm whale click train events from 10 groups were detected during off-effort transits over the three surveys. Of the on-effort click train events, a total of 625 events from 150 groups were able to be localized to obtain depth-corrected perpendicular distances from the trackline for use in density and abundance estimation. These included four whales from one group during the summer 2017 survey and 6 whales from one group during the winter 2018 survey that were detected at the ship track turns and were localized to two independent sample lines with both localizations included in the Distance sampling analyses. Across the three surveys, 15 detected whales could not be localized due to ship turns or data recording issues, including one group of seven whales during the summer-fall 2018 cruise. Localizations and associated distances were estimated to what appeared to be individual whales in most, but not all, cases. Therefore, click train clusters (defined above) were used as "clusters" in the Distance analyses with mean sizes of 1.111, 1.022, and 1.077 whales for the summer 2017, winter 2018, and summer-fall 2018 cruises, respectively. However, multiple individuals or clusters of echolocating whales (groups) were typically observed in close proximity, and mean (\pm standard

deviation) group sizes were 4.3 ± 3.37 (range: 1-16), 4.6 ± 3.21 (range: 1-12), and 3.8 ± 3.02 (range: 1-14) for the three cruises, respectively (Figure E-1).

Table 18. Post-processing results of sperm whale click train event selection and localization

	Summer 2017	Winter 2018	Summer/Fall 2018
On-effort trackline (km)	7,021	5,210	6,378
On-effort trackline samples	86	64	96
On-effort sperm whale groups detected	64	27	58
On-effort click train events detected (min/best/max)	257/276/314	131/134/161	195/220/274
On-effort group size (mean \pm st.dev)	4.3 ± 3.37	4.6 ± 3.21	3.8 ± 3.02
Sperm whale groups localized	64 (69)	29	57 (61)
Click train events localized*	291 (320)	139	195 (232)

*In a few cases, detected events were localized to two tracklines when they met.

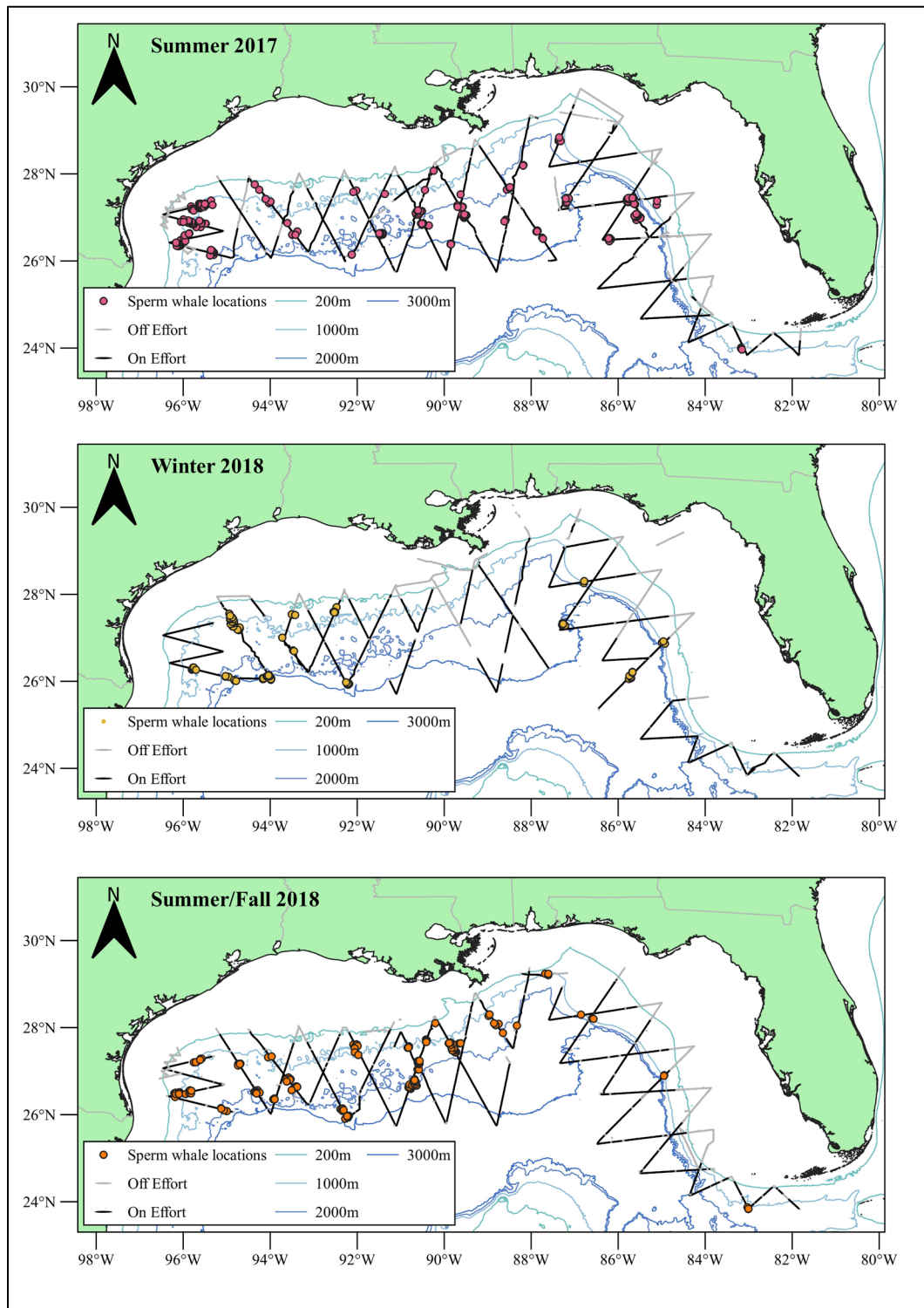

Figure 19. Sperm whale acoustic localizations for the three GoMMAPPS seasonal vessel-based surveys.

For each of the three seasonal surveys, a different model type was selected as the best fit model for the sperm whale acoustic detection function, with a hazard rate model selected for summer 2017 survey data, a uniform model with order 1 cosine adjustments for winter 2018 survey data, and a half-normal model for summer-fall 2018 survey data (Table E-1, Figure E-2). The estimated detection probabilities for the models ranged between 0.58 and 0.78 for the three surveys, while the effective strip widths ranged between 3.1 and 6.4 km. The summer 2017 cruise had the highest detection probability and effective strip width, while the winter 2018 had the lowest detection probability and effective strip width. For each of the surveys, detection function models are shown in Figure E-2 and detection function model parameters are included in Table E-1.

For all three surveys, there was a decline in the number of click train events detected near the trackline (Figure E-2), even though we corrected acoustic slant ranges to horizontal distances based on an assumed whale depth of 800 m. However, in all cases, visual inspection of the Q-Q plots showed a reasonable fit (Figure E-2) and the Kolmogorov-Smirnov GOF tests and Cramer-von Mises tests had p-values that were non-significant ($p > 0.05$) (Table E-2), indicating that the selected models for the detection function fits were adequate. Left truncation of the data was explored; in the summer cruises, densities increased slightly when this truncation was applied. The spiked distribution in the 300–600 m bin for winter 2018 led to left-truncated models with nearly triple the density of non-truncated data. Because the GOF tests indicated that the model fits for the data without left-truncation were adequate and the winter models with and without left truncation produced dramatically different results, we report only the model results without left truncation.

Stratified acoustic encounter rates estimates for each of the surveys showed high variability among strata and among surveys (Table E-3). In general, encounter rates were lowest in the east across cruises, with the exception of the summer 2017 cruise in which they were similar to, but higher than, acoustic encounter rates in the central strata. The difference was most dramatic in summer-fall 2018 when encounter rates in the central strata (0.040 whales/km) and the western strata (0.054 whales/km) were an order of magnitude higher than in the eastern strata (0.003 whales/km). Conversely, encounter rates in the west were highest compared to the other two strata in all three surveys. The difference was greatest in summer 2017, which had the highest encounter rates overall with 0.167 whales/km in the west, compared to east and central with encounter rates of 0.029 and 0.022 whales/km, respectively. Winter 2018 had the most consistent encounter rates across strata, ranging between 0.014 and 0.032 whales/km. This variation in acoustic encounter rates among strata and surveys reflects the distributional changes noted during the concurrent visual surveys.

Patterns in density followed the same patterns as seen for encounter rates among strata and surveys (Table 19). Across the stratified models, the variation in density was primarily driven by variation in encounter rates, explaining between 93.2% and 99.3% of the variation, with the remaining variation explained by variation in the detection functions (Table E-3). In all cases, the percentage of variance explained by detection function variance was less than 3%, with the exception of the central strata during the summer-fall 2018 survey when the percentage variance explained by the detection function was 6.8%. This stratum also had the highest number of detections of all strata on the three surveys, with 136 detections; the next highest number of detections per stratum was 89 detections.

Table 19. Stratified and pooled sperm whale acoustic density and abundance estimates from the three GoMMAPPS seasonal vessel-based surveys

Density (D) is estimated as number of animals per km².

	Estimate	CV	df	95% CI lower	95% CI upper
Summer 2017 - Hazard/Polynomial					
East					
D	0.00230	0.382	37.68	0.00109	0.00486
N	326	0.382	37.68	154	688
Central					
D	0.00169	0.217	41.3	0.00110	0.00261
N	341	0.217	41.3	221	527
West					
D	0.01310	0.237	7.35	0.00758	0.02263
N	331	0.237	7.35	192	573
Pooled					
D	0.00271	0.168	64.07	0.00194	0.00377
N	998	0.168	64.07	716	1392
Winter 2018 - Uniform/cosine					
East					
D	0.00223	0.571	23.44	0.00074	0.00668
N	315	0.571	23.44	105	945
Central					
D	0.00506	0.418	30.05	0.00223	0.01148
N	1022	0.418	30.05	450	2320
West					
D	0.00509	0.687	6.08	0.00112	0.02319
N	129	0.687	6.08	28	587
Pooled					
D	0.00398	0.324	43.82	0.00210	0.00752
N	1466	0.324	43.82	775	2773
Summer/Fall 2018 - Half-normal/cosine					
East					
D	0.00039	0.565	40.23	0.00013	0.00113
N	55	0.565	40.23	19	160
Central					
D	0.00530	0.270	55.14	0.00311	0.00901
N	1070	0.270	55.14	628	1821
West					
D	0.00722	0.425	6.34	0.00270	0.01929
N	183	0.425	6.34	68	488
Pooled					
D	0.00355	0.233	65.47	0.00224	0.00562
N	1308	0.233	65.47	826	2071

Acoustic-based sperm whale abundance estimates for the three seasonal GoMMAPPS cruises were 998 whales (CV: 0.168) in summer 2017, 1,466 whales (CV: 0.324) in winter 2018, and 1,308 whales (CV: 0.233) in summer-fall 2018 (Table 19). Stratified abundance estimates and associated uncertainty for each survey are shown in Table 19. The uncertainty around the pooled abundance estimates is relatively low to

moderate ranging between 0.17–0.32, while the uncertainty associated with the stratified rates are moderate to high ranging between 0.23 and 0.69 (Table 19). Acoustic abundance estimates for summer 2017 and summer-fall 2018 were similar to visual abundance estimates from the same cruises, with estimates of 1,078 (CV: 0.293), 644 (CV: 0.463) (SEFSC, unpublished data), and 1,307 (CV: 0.326) sperm whales from summer 2017, winter 2018, and summer-fall 2018 visual surveys, respectively (Table 20). These visual survey estimates have not accounted for availability bias and it is expected that true abundances are higher. The average total abundance for 2015–2019 from the SDM model for August (summer) and January (winter) are presented for comparison and do account for the estimated availability bias (see Appendix C).

Table 20. Comparison of sperm whale abundance estimates by analysis method

Visual survey estimates have not accounted for availability bias and it is expected that true abundances are higher. The average total abundance for 2015–2019 from the SDM model for August (summer) and January (winter) are presented for comparison and do account for the estimated availability bias (see Appendix C).

Abundance estimation method	Summer 2018	Winter 2018	Summer/Fall 2018
Passive Acoustic - Distance analysis	998 (0.168)	1,466 (0.324)	1,308 (0.233)
Visual Survey - Distance analysis	1,078 (0.293)	644 (0.463)	1,307 (0.326)
SDM	2, 451 (0.126)	1,120 (0.218)	2,451 (0.126)

3.4 Spatial Density Models

Spatial density model results are contained in individual chapters for each species (Appendix C for marine mammals and Appendix D for sea turtles). Each chapter contains detailed information about sightings during vessel or aerial surveys, model selection and fit for the detection probability component of the SDM, model selection for the GAM component of the model and resulting spatial projections. For the oceanic dolphin, small whale, and hardshell turtle species, sightings that could not be identified to species were apportioned among the identified species based upon SDMs for these taxa groups (see Appendix C.16 for Unidentified Stenellid Dolphins, C.17 for Unidentified Dolphins, C.18 for Unidentified Small Whales, and D.5 for Unidentified Hardshell Turtles). Overall model results for each species model are summarized here.

3.4.1 Sperm Whales

Sperm whales occurred throughout the deep waters of the NGOM during all vessel surveys. During the 2003, 2004, and 2009 surveys, there were many sightings in the northeastern GOM in waters with relatively high chlorophyll-a content and to the north of the Loop Current or a separated Loop Current eddy. During the 2017 and 2018 surveys, waters with higher sea surface height anomaly and generally lower surface water productivity dominated the NGOM, and sperm whale sightings occurred primarily in the central and western GOM and were less frequent in the northeastern GOM (Figures C.1-2–C.1-7). The SDM selected included water depth, sea surface temperature, sea level anomaly (SLA), surface salinity, and geostrophic velocity (GV) magnitude as explanatory factors (Table C.1-6). The model predicted higher sperm whale densities in waters with low surface velocity less influenced by the Loop Current or Loop Current eddies. The positive effect of sea surface temperature was primarily associated with higher densities during summer months and the overall low density observed in the winter (Figures C.1-15–C.1-26). Overall, the model indicates that sperm whales occurred in highest densities in deeper slope waters that are less influenced by the Loop Current or Loop Current eddies and during summer months. The variability in the oceanographic conditions in the NGOM between the 2003–2009 and 2017–2018 surveys

likely account for the observed shifts in spatial distribution and lower sperm whale density in the northeastern GOM. Projecting the model to regions of the southern GOM suggests high densities of sperm whales in regions with similar oceanographic features, in particular in the southeastern GOM near the Yucatan channel (Figures C.1-27–C.1-38).

3.4.2 Rice's Whales

The endangered Rice's whales are the only resident baleen whale in the NGOM and have primarily been observed in a restricted habitat of the northeastern GOM off the coast of Florida. During vessel surveys conducted from 2003 to 2019, Rice's whales were primarily observed in the northeastern GOM near the 220-m isobath. One confirmed Rice's whale was observed in the western GOM near the shelf break off the coast of Texas (Figure C.2-1). As noted above, due to the small number of sightings during the primary surveys, additional Rice's whales sightings were included in the detection function that were observed during other SEFSC vessel surveys (Garrison et al. 2020). The selected SDM included depth, log(chlorophyll-a concentration), bottom temperature (BST), bottom salinity (BSS), and the u and v components of geostrophic velocity (Table C.2-4). The selected model indicated that Rice's whale density was highest in shallow waters and with intermediate bottom temperatures between 10 and 19°C and intermediate surface chlorophyll-a concentrations (Figure C.2-5). The combination of physical characteristics, and resulting predicted higher numbers of Rice's whales, occurred primarily in the northeastern GOM core habitat. In addition, a narrow band of similar habitat occurs along the shelf break and in the western GOM where there is a similar north-south orientation of the bathymetry. There is some seasonal variability in predicted density associated with changes in water column characteristics (Figures C.2-6–C.2-17). While vessel survey effort is restricted to the NGOM, and Rice's whales are only known to occur in the NGOM, it is possible that they occur in habitats of the southern GOM. The projection of the resulting SDM beyond the NGOM assumes that species-habitat relationships are consistent, and it is unknown if this assumption is reliable. To evaluate potential areas with suitable habitats for Rice's whales, the SDM was projected throughout the GOM. These results should be interpreted with caution given the extrapolation outside of the surveyed area. Potential areas of high density include regions with similar bathymetric and current fields to the core habitat, in particular in waters off the Campeche Bank (Figures C.2-18–C.2-29).

3.4.3 Pygmy and/or Dwarf Sperm Whales

Pygmy and dwarf sperm whales of the genus *Kogia* occur throughout the deep waters of the NGOM. Visual surveys for these species are challenging because of their small body size and “logging” behavior while at the surface. Very few groups were observed at sea states greater than 2, and therefore the detection probability model and SDM used only survey effort and sightings when sea state was less than 3. Because good weather conditions occurred so rarely during the winter 2018 survey, these data were not included in the SDM, and the model cannot be used to predict animal density during cold months (December–March). In addition, the low visibility of these species reduced the number of resights by the two survey teams, and therefore it was not possible to estimate detection probability on the trackline for this analysis. *Kogia* spp. sightings were observed in the northeastern GOM in waters with relatively high chlorophyll-a content and to the north of the Loop Current or separated Loop Current eddies during the 2003, 2004, and 2009 surveys. However, during 2017–2018, *Kogia* spp. were less prevalent in the northeastern GOM and occurred in waters with generally low or negative sea level anomaly and intermediate chlorophyll-a concentrations (Figures C.3-2–C.3-6). The selected SDM included distance to the shelf break, geostrophic velocity, log(chlorophyll-a concentration), and sea level anomaly as explanatory factors (Table C.3-4). The selected model indicated that *Kogia* spp. density was highest in generally deeper waters with neutral or negative sea surface anomaly and low velocities. Overall, the model indicates that *Kogia* spp. occur in highest densities in deep slope waters that are less influenced by

the Loop Current or Loop Current eddies (Figures C.3-11–C.3-18). Projecting this model into the southern GOM suggests higher densities of *Kogia* spp. in the deep slope waters of the central GOM (Figures C.3-19–C.3-26).

3.4.4 Beaked Whales

Beaked whales of the genera *Ziphius* and *Mesoplodon* are deep diving marine mammals that occur throughout the deep waters of the NGOM. Because of the low availability of beaked whales at the surface and the challenge of seeing them when at the surface, there were very few confirmed resights by the two independent survey teams. Therefore, it was not possible to estimate detection probability on the trackline. Though multiple species were observed, very few sightings could be identified to species, and therefore all species were combined into a common “beaked whale” category for this analysis. Sightings were observed in waters with relatively high chlorophyll-a content and to the north of the Loop Current or a separated Loop Current eddy in the northeastern and central portions of the NGOM (Figures C.4-3–C.4-8). The selected model included average depth, sea surface temperature, geostrophic velocity, and sea level anomaly (Table C.4-4, Figure C.4-13). The selected model indicated that beaked whale density was highest in generally deeper waters with neutral or negative sea surface anomaly. The positive sea surface temperature effect is primarily associated with higher densities during summer months and the overall low density observed in the winter. Overall, the model indicates that beaked whales occur in highest densities in deeper slope waters that are less influenced by the Loop Current or Loop Current eddies (Figures C.4-14–C.4-25). Beaked whale had a bimodal depth distribution with high densities in the central and western GOM between the 1000 and 2000 m isobaths and in the deeper waters of the central GOM. When the model is projected into the southern GOM, it predicts very high beaked whale densities in the southeastern GOM in the Yucatan and Florida Straits (Figures C.4-26–C.4-37).

3.4.5 Short-finned Pilot Whales

Short-finned pilot whales are observed primarily in inner continental slope waters of the western NGOM. They were observed more frequently in waters with negative sea surface height anomaly values and intermediate surface chlorophyll levels, and there were a greater number of sightings in the western GOM during the 2017–2018 surveys compared to 2003, 2004, and 2009 (Figures C.5-2–C.5-7). The selected model included average depth, distance to canyons, sea surface temperature, East-West current velocity strength, and Easting (Table C.5-6). The selected model indicated that pilot whale density was highest in waters of relatively shallow depth and in the western GOM (lower values of Easting coordinate). Pilot whale density was also higher in waters with positive values in the east-west velocity component. The positive effect of sea surface temperature is primarily associated with higher densities during summer months and the overall low density observed in the winter (Figure C.5-13). Overall, the model indicates that pilot whales occur in highest densities in inner slope waters that are less influenced by the Loop Current or Loop Current eddies. Monthly prediction maps indicate high predicted densities in waters between the 1,000–2,000 m isobaths and in the western GOM and during warmer months (Figures C.5-14–C.5-25). Projecting the model into the southern GOM suggests high densities of pilot whales extending into the southwestern GOM and the Bay of Campeche (Figure C.5-38–C.5-49).

3.4.6 Melon-headed Whales, False Killer Whales, and Pygmy Killer Whales (Blackfish)

Species including false killer whales, pygmy killer whales, and melon-headed whales (“blackfish”) are encountered occasionally during any given vessel survey, and these relatively infrequent encounters make it difficult to fit species-specific detection and habitat models. Also, it can be difficult to identify them to species unless the vessel approaches the group closely. For these reasons, these three species (and sightings for which a definitive identification could not be made) were combined in the current analysis.

Blackfish were observed throughout the deep waters of the NGOM during all vessel surveys, with the majority of sightings occurring in the central and western portion of the NGOM, particularly in the more recent 2017–2018 survey (Figures C.6-2–C.6-7). For blackfish, the selected model included log(chlorophyll-a concentration) and East-West current velocity strength (Table C.6-6), resulting in a fixed spatial model. The lack of fit with dynamic environmental parameters likely reflects both the rarity of these species and combining species that may have different responses to the environment in the same model. The selected model indicated that blackfish density was highest in waters of the northeastern GOM (Figure C.6-13). Limited information is available about species-environment relationships due to the relatively small number of encounters. Because only spatial terms are included in the model, there is no seasonal or inter-annual variability in predicted densities (Figure C.6-14–C.6-25). Projections into the southern GOM are of limited reliability because only spatial components are included in the model (Figures C.6-38–C.6-49).

3.4.7 Common Bottlenose Dolphins

There are multiple stocks of common bottlenose dolphins in the NGOM including Coastal and Continental Shelf stocks that occur in waters less than 200 m deep and the oceanic stock that occurs in waters of the inner continental slope. The Shelf and Coastal bottlenose dolphin stocks are assessed using aerial surveys, and the oceanic stock waters are covered during large vessel surveys. The boundary between the two survey areas is defined by the continental shelf break at roughly the 200-m isobath.

In aerial surveys of waters over the continental shelf, bottlenose dolphins were observed throughout the survey range (between Key West, Florida and Brownsville, Texas) in all seasons with higher densities of animals typically occurring close to the shoreline. A region of persistent high occurrence was apparent in waters along the southern coast of Louisiana. There were apparent seasonal differences in distribution, with larger numbers of animals occurring in the western GOM during summer and fall months. Sightings tend to occur more frequently in nearshore waters with high chlorophyll-a concentrations with lower densities further from shore and in lower productivity areas (Figures C.7-2–C.7-8). The selected SDM included average depth, sea surface temperature, distance from shore, distance from canyons, and the Northing coordinate (Table C.7-4). In addition, a “year” factor variable was included in the model to reflect the overall higher density of bottlenose dolphins in the 2017–2018 surveys compared to 2011–2012 surveys. Predicted bottlenose dolphin density was highest in waters close to shore. However, there were also lower peaks in density at intermediate water depths. Density declined rapidly in waters greater than 100 m depth. The sea surface temperature effect reflects higher densities observed in winter and summer months with lower density in seasons with intermediate temperatures (Figure C.7-12). The highest dolphin densities occurred in waters of the central northern GOM along the coast of Louisiana (Figures C.7-13–C.7-24).

In vessel-based surveys of oceanic waters, bottlenose dolphin sightings occurred primarily in waters near the shelf break with the majority of sightings occurring in the eastern GOM. There were, however, several sightings in the western GOM during the 2017–2018 surveys where bottlenose dolphins were not observed during 2003–2009 (Figures C.8-2–C.8-7). The selected SDM included average depth, sea surface temperature, sea level anomaly, surface salinity, distance to shore, and the u and v components of geostrophic velocity (Table C.8-6). The selected model indicated that bottlenose dolphin density was highest in generally shallow waters near the shelf break. Dolphin density was also higher in waters with negative SLA values and strong southward flowing (negative “v” component) waters. The positive sea surface temperature effect is primarily associated with higher densities during summer months and the overall low density observed in the winter (Figure C.8-13). Overall, the model indicates that bottlenose dolphins occur in waters near the shelf break and in regions of negative SLA waters that are less influenced by the Loop Current or Loop Current eddies. The spatial model predicts high bottlenose

dolphin densities in shelf break waters between the 200 and 1,000-m isobaths and higher abundance during warm months (Figures C.8-14–C.8-25). Projecting the model into the southern GOM suggests high bottlenose dolphin densities in shelf break and inner continental slope waters throughout the GOM (Figures C.8-38–C.8-49).

3.4.8 Atlantic Spotted Dolphins

Atlantic spotted dolphins occur in the NGOM in both coastal and continental shelf waters less than 200 m deep and in oceanic waters of the inner continental slope. The shelf and coastal waters are assessed using aerial surveys, while the oceanic waters are covered during large vessel surveys. The boundaries between the two survey areas are defined by the continental shelf break at roughly the 200-m isobath.

Over the continental shelf, Atlantic spotted dolphins were observed throughout the surveyed range in all seasons with higher densities of animals typically occurring on the outer continental shelf near the shelf break. There was a region of high occurrence in the northeastern GOM south of the Florida Panhandle where deeper water occurs relatively close to shore. Sightings tended to occur more frequently in offshore waters with lower chlorophyll-a concentrations. West of the Mississippi River Delta, Atlantic spotted dolphins occurred very close to the shelf break and they occurred in shallower water over the west Florida shelf in the eastern GOM (Figures C.9-2–C.9-8). The selected SDM included average depth and log(chlorophyll-a concentration) (Table C.9-4). In addition, a “year” factor variable was included in the model to reflect the overall higher density of Atlantic spotted dolphins in the 2017–2018 surveys compared to prior years. The selected model indicated that Atlantic spotted dolphin density was highest in waters in the outer continental shelf with peak densities at approximately 100 m depth and in waters with lower chlorophyll-a concentrations (Figure C.9-12). Variability in chlorophyll concentrations result in changes in the overall estimated population size with the highest population estimates in spring and summer months (Figures C.9-13–C.9-24).

In vessel surveys of oceanic waters, Atlantic spotted dolphins were rarely observed in the shelf break waters of the NGOM, and sightings occurred in both the eastern and western NGOM (Figures C.10-2–C.10-7). Sightings of Atlantic spotted dolphins in the western GOM were more frequent during the 2017–2018 vessel surveys. The selected SDM included average depth and Easting (Table C.10-6) and predicted higher density in shallower waters and in the western GOM (Figure C.10-13). The resulting SDMs do not predict seasonal variation in spatial distribution because only static variables are included (Figures C.10-14–C.10-25). Because only spatial variables are included in the model, projection of Atlantic spotted dolphin density throughout the GOM is less reliable.

3.4.9 Risso's Dolphins

Risso's dolphins were observed throughout the deep waters of the NGOM during all vessel surveys with sightings occurring in the throughout the NGOM. During surveys conducted 2017–2018, there were fewer Risso's dolphin sightings in the deep waters of the western GOM compared to surveys during 2003–2009. They were observed more frequently in waters with negative sea surface height anomaly values and intermediate surface chlorophyll levels (Figures C.11-2–C.11-7). The selected SDM included average depth, distance to shore, distance to canyons, sea surface temperature, and sea level anomaly (Table C.11-6). Surface salinity was retained in the model but was not statistically significant. The selected model indicated that Risso's dolphin density had a bimodal distribution with higher densities near in both the northern and southern portions of the GOM and lower densities in intermediate locations. The bulk of the detections were associated with low SLA values, though some sightings also occurred in Loop Current waters with positive SLA (Figure C.11-13). Overall, the model indicates that Risso's dolphins occur in a mixed range of habitats over the continental slope of the NGOM. A significant year

class factor indicated significantly lower overall density during 2017–2018 compared to 2003–2009. Monthly prediction maps demonstrate variability in animal density resulting from variability in the underlying physical oceanography. In particular, variability in surface currents results in changes in the overall estimated population size over time (Figures C.11-14–C.11-25). The selected model becomes highly uncertain as it is extrapolated into the southern GOM, and suggests that majority of Risso’s dolphin density occurs in the NGOM (Figures C.11-38–C.11-49).

3.4.10 Pantropical Spotted Dolphins

Pantropical spotted dolphins were observed throughout the deep waters of the NGOM during all vessel surveys, and are one of the most common and abundant species seen in the slope and abyssal waters of the NGOM. During the 2003, 2004, and 2009 surveys, large numbers of sightings occurred in the northeastern GOM in waters with relatively high chlorophyll-a content and to the north of the Loop Current or a separated Loop Current eddy. Pantropical spotted dolphins were observed in lower numbers and more spread out east to west in the NGOM during the 2017 and 2018 surveys when slope waters were dominated by waters with higher sea surface height anomaly and generally lower surface water productivity (Figures C.12-2–C.12-7). The selected SDM included average depth, sea surface temperature, sea level anomaly, surface salinity, log(chlorophyll-a concentration), and Easting (Table C.12-6). In addition, a “year” factor variable was included in the model to reflect the lower density of pantropical spotted dolphins in the 2017–2018 surveys compared to prior years. Pantropical spotted dolphin density was highest in generally deeper, higher salinity waters and in waters with negative SLA values and further east in the NGOM. The positive sea surface temperature effect is primarily associated with higher densities during summer months and the overall low density observed in the winter (Figure C.12-13). Overall, the model indicates that pantropical dolphins occur in highest densities in deeper slope waters with negative SLA values that are less influenced by the Loop Current or Loop Current eddies. Monthly prediction maps demonstrate variability in animal density resulting from variability in the underlying physical oceanography. In particular, variability in water temperatures and the occurrence of negative SLA waters result in changes in the overall estimated population size over time (Figures C.12-14–C.12-25). Projecting the model into the southern GOM suggested areas of high density include regions with negative SLA values particularly in the southeastern GOM (Figures C.12-38–C.12-49).

3.4.11 Striped Dolphins

Striped dolphins were observed in the slope and deep waters of the NGOM. During the 2003, 2004, and 2009 surveys, sightings were observed in the central-eastern GOM in waters with relatively high chlorophyll-a content and to the north of the Loop Current or a separated Loop Current eddy. No sightings were recorded in 2017. In the 2018 surveys, sightings were recorded also in the central-eastern GOM but during the winter survey (GU18-01), one sighting was seen further to the west (Figures C.13-2–C.13-7). For striped dolphins, the selected model included distance to the shelf break, log(chlorophyll-a concentration), and Easting (Table C.13-6). Though these terms were retained in the model, none were statistically significant. These static spatial variables were retained to provide a model that generally describes striped dolphin distribution. Because the variables retained in the SDMs are static spatial variable, there is no predicted seasonal variability in striped dolphin distribution. The model generally predicted higher striped dolphin densities in the deeper waters of the eastern NGOM (Figures C.13-14–C.13-25). Projecting the model into the southern GOM suggests striped dolphins occur throughout the eastern GOM into the Yucatan Channel; however, the projection of the model is highly uncertain (Figures C.13-38–C.13-49).

3.4.12 Clymene Dolphins

Clymene dolphins were observed in the deep waters of the NGOM. During the 2003 and 2004 surveys, large numbers of sightings were observed in the western GOM, and in 2009 one sighting was recorded in the northeast in waters with a relatively high chlorophyll-a content. In the 2017 survey one sighting was recorded in the central NGOM and in the winter 2018 survey, one sighting was seen in the southeast in waters at the edge of the Loop Current (Figures C.14-2–C.14-7). The selected SDM included distance to shore, the north-south component of sea surface velocity, log(chlorophyll-a concentration), and Easting (Table C.14-6). In addition, a “year” factor variable was included in the model to reflect the lower density of Clymene dolphins in the 2017–2018 surveys compared to previous years. The model indicated that Clymene dolphin density was highest in generally deeper waters of the western GOM and in waters with negative SLA values that are less influenced by the Loop Current or Loop Current eddies (Figure C.14-13). Monthly prediction maps demonstrate variability in animal density resulting from variability in the underlying physical oceanography. In particular, variability in the occurrence of negative SLA waters result in changes in the overall estimated population size over time (Figures C.14-14–C.14-25). The projection of the model into the southern GOM suggests that Clymene dolphins occur throughout the western and southwestern GOM and in deeper habitats of the central GOM (Figures C.14-38–C.14-49).

3.4.13 Spinner Dolphins

Spinner dolphins occur in waters with steep bottom gradients and are primarily observed east of the Mississippi River Delta along the Florida Escarpment. During the 2003, 2004, and 2009 surveys, spinner dolphin sightings were observed in the northeastern GOM in waters with relatively high chlorophyll-a content and to the north of the Loop Current. No sightings were recorded in 2018, and in 2017 only one sighting was seen in the northeast GOM, similar to the previous surveys, and one was recorded further south at the edge of the Loop Current (Figures C.15-2–C.15-7). The selected spatial model included distance to shore and Easting (Table C.15-6). In addition, a “year” factor variable was included in the model to reflect the lower density of dolphins in the 2017–2018 surveys compared to prior years. The model indicated that spinner dolphin density was highest in waters at intermediate distances from shore with lower salinity values in the eastern NGOM. Dolphin density was also higher in waters with low geostrophic velocities (Figure C.15-13). Variability in the presence of Loop Current eddies results in predicted changes in the overall estimated population size over time (Figures C.15-14–C.15-25). Spinner dolphin density was predicted to be highest in the northeastern GOM along the shelf break in waters that were less influenced by the Loop Current. Projecting the model into the southern GOM indicated high densities in the southeastern GOM into the Yucatan straits (Figures C.15-38–C.15-49).

3.4.14 Leatherback Turtles

Leatherback turtles were observed during all seasons, but nearly all sightings in winter and spring were east of the mouth of the Mississippi River. Sightings tended to occur more frequently in offshore waters with lower chlorophyll-a concentrations (Figures D.1-2–D.1-8). The selected SDM included average depth, sea surface temperature, distance to the shelf break, distance to canyons, log(chlorophyll-a concentration), and mixed layer depth (Table D.1-4). The model indicated that leatherback turtle density was higher in offshore waters deeper than 50 m. The effect of distance from continental shelf edge shows higher density in the middle of the continental shelf. The sea surface temperature effect reflects the higher densities and wider distribution throughout the area observed in the summer and fall with lower density in the central NGOM during the winter. The regional east-west shelf factor indicated differences in leatherback turtle densities between the areas east and west of the mouth of the Mississippi River, with overall density being higher in the eastern area (Figure D.1-12). Monthly prediction maps demonstrate variability in animal density resulting from variability in the underlying physical oceanography. In

particular, variability in temperature results in changes in the overall estimated population size with the highest population estimates in the summer months (Figures D.1-13–D.1-24).

3.4.15 Green Turtles

Green sea turtles were observed primarily in the eastern and southeastern NGOM in all seasons and in the western NGOM during summer 2011 (Figures D.2-2–D.2-8). The selected model included average depth, sea surface temperature, log(chlorophyll-a concentration), mixed layer depth, and Easting (Table D.2-4). The model indicated that green turtle density was highest in waters close to shore and in warm water temperatures in the eastern GOM (Figure D.2-13). Monthly prediction maps demonstrate variability in animal density resulting from variability in the underlying physical oceanography (Figures D.2-14–E.2-25).

3.4.16 Kemp’s Ridley Turtles

Kemp’s ridley turtles were observed throughout the surveyed range in all seasons (Figures D.3-2–D.3-8). The selected model included average depth, sea surface temperature, distance from shore, distance from canyons, distance from the shelf break, log(chlorophyll-a concentration), mixed layer depth, and Easting (Table D.3-4). The model indicated that Kemp’s ridley turtle density was highest at intermediate water depths and declined rapidly in waters greater than 15 m depth. The sea surface temperature effect reflects higher densities observed in winter months (Figure D.3-13). Monthly prediction maps demonstrate variability in animal density resulting from variability in the underlying physical oceanography (Figures D.3-14–D.3-25).

3.4.17 Loggerhead Turtles

Loggerhead turtles were observed throughout the coastal and shelf waters during all seasons, with the highest occurrence in the eastern NGOM and in nearshore waters of the central NGOM. Sightings in the western NGOM occurred in greater numbers during summer and fall surveys (Figures D.4-2–D.4-8). The selected model included average depth, sea surface temperature, distance from shore, distance from canyons, log(chlorophyll-a concentration), mixed layer depth, and Easting (Table D.4-4). The model indicated that loggerhead turtle density was highest in waters close to shore. However, there were also peaks in density at intermediate water depths. Density declined rapidly in waters greater than 100 m. The sea surface temperature effect reflects higher densities observed in winter and summer months with lower density in seasons with intermediate temperatures (Figure D.4-13). Monthly prediction maps demonstrate variability in animal density resulting from variability in the underlying physical oceanography (Figures D4-14–D.4-25).

3.4.18 SDM Abundance Estimates Compared to Distance Sampling Abundance Estimates

Both standard line-transect Distance analysis (“Distance sampling”) and the SDM models can provide estimates of total abundance of each species within a defined region, in this case the US waters of the NGOM. Though the underlying data between the two methods are the same (i.e., on effort sightings and survey effort), there are also important analytical differences that are expected to lead to differences in total estimated abundance between the two methods. These differences are especially important when comparing estimated abundance for managed species with those reported in NMFS MMPA SARS (e.g., Hayes et al. 2022). The estimates reported in the current SARS are the weighted average of those from the summer 2017 and summer-fall 2018 surveys (Table 21) (Garrison et al. 2020). These are the current best estimates of abundance for each species/stock for management purposes.

Estimates of total abundance from the SDM models were obtained by summing the average (across months) predicted density across spatial cells from the 2015–2019 prediction maps (Table 21). These are comparable to the Distance analysis estimates in that 1) they cover the same area, 2) they reflect abundance in recent years, and 3) both share the same underlying data and estimation methods for detection probability on the trackline and detection within the surveyed strip. As a result, it is expected that they should be similar to one another. In general, this is the case and all estimates are of the same order of magnitude between the two methods. However, there are some notable differences associated with methodological differences. First, for many species, the annual averages from the SDM models reflect both cold and warm periods of the year, as opposed to the Distance estimates that are only from data collected in warm months. For some species, the selected SDM models included water temperature and, therefore, overall density and abundance varied with season. Second, for sperm whales and beaked whales, tag telemetry data were summarized and corrections for availability bias were included in the SDM models. This likely accounts for the two-fold difference in estimated beaked whale abundance between the SDM and Distance analysis. Third, for many species, the SDM model included spatially explicit apportionment of unidentified animals (e.g., unidentified dolphins and unidentified small whales). In contrast, the Distance analysis methods apportioned unidentified animals at a regional level. The greater resolution of the SDM approach may lead to differences in the apportioning of unidentified sightings. Fourth, for *Kogia* spp., the SDM included only survey effort conducted at sea states ≤ 2 since survey effort in poor conditions was not effective at detecting this cryptic taxa. This difference likely accounts for the higher abundance of *Kogia* spp. from the SDM. Fifth, for sea turtles, the SDM model includes apportionment of unidentified hardshell turtles while the Distance analysis does not. This accounts for the substantial differences in abundance estimates for green, loggerhead, and Kemp's ridley turtles. Finally, for Rice's whales, the SDM projects the density outside of the core habitat in the northeastern GOM and thus includes a larger spatial area than the Distance analysis estimate. In addition, the Rice's whale SDM predicts higher abundance during cold months, which may be an artifact of limited data collected during the winter (i.e., only the winter 2018 survey). Given the limited number of Rice's whale sightings outside of the core area, the projection of density and resulting higher total abundance should be treated with caution. In general, the differences between the SDM and Distance analysis estimates can be tied to specific analytical differences between the approaches.

Table 21. Abundance estimates from each species derived from SDMs and standard line-transect Distance Analysis methods

Unid = unidentified

Species	SDM Annual Average Abundance (CV)	Distance Analysis Abundance (CV)	Analytical Differences
Sperm whale	1,702.7 (0.051)	1,180.4 (0.219)	SDM includes availability bias correction, SDM includes cold-water months
Rice's whale	121.1 (0.115)	51.3 (0.503)	SDM includes broader spatial area, SDM includes cold-water months
<i>Kogia</i> spp.	1,014.6 (0.098)	336.2 (0.346)	SDM restricted analysis to Sea States < 2
Beaked whale	602.4 (0.099)	316 (0.278)	SDM includes availability bias correction, SDM includes cold-water months
Pilot whale	1,925.8 (0.096)	1,321.1 (0.430)	SDM includes spatial apportionment of unid. small whales, SDM includes cold-water months
Blackfish	6,701.4 (0.121)	3,124 (0.466)	SDM includes spatial apportionment of unid. small whales, SDM includes cold-water months
Shelf bottlenose dolphin	120,597 (0.038)	111,989 (0.072)	None
Oceanic bottlenose dolphin	10,299.4 (0.101)	7,462.1 (0.313)	SDM includes spatial apportionment of unid. dolphins, SDM includes cold-water months
Shelf Atlantic spotted dolphin	10,154.9 (0.096)	15,929 (0.320)	SDM includes cold-water months
Oceanic Atlantic spotted dolphin	1,900.3 (0.147)	5,577.01 (0.414)	SDM includes spatial apportionment of unid. dolphins, SDM includes cold-water months
Risso's dolphin	852.3 (0.144)	1,973.5 (0.456)	SDM includes spatial apportionment of unid. small whales, SDM includes cold-water months
Pantropical spotted dolphin	37,192 (0.123)	37,195.1 (0.244)	SDM includes spatial apportionment of unid. dolphins, SDM includes cold-water months
Striped dolphin	8,197 (0.150)	1,816.6 (0.558)	SDM includes spatial apportionment of unid. small whales, SDM includes cold-water months
Clymene dolphin	3,342.5 (0.288)	513.2 (1.033)	SDM includes spatial apportionment of unid. small whales, SDM includes cold-water months
Spinner dolphin	1,481.1 (0.233)	2,991 (0.540)	SDM includes spatial apportionment of unid. small whales, SDM includes cold-water months
Leatherback turtle	2,579.9 (0.109)	4,770.4 (0.265)	None
Green turtle	5,693.6 (0.109)	3,658.1 (0.366)	SDM includes spatial apportionment of unid. turtles
Kemp's ridley turtle	116,101 (0.072)	64,517.4 (0.113)	SDM includes spatial apportionment of unid. turtles
Loggerhead turtle	187,997.5 (0.309)	69,909.3 (0.100)	SDM includes spatial apportionment of unid. turtles

4 Conclusions, Discussion, and Data Gaps

The GoMMAPPS study resulted in updated abundance estimates for all continental shelf and oceanic marine mammal stocks in the NGOM along with abundance estimates for four species of sea turtles. In addition, we developed spatial density models for oceanic and shelf marine mammal species that provide insight into observed trends in animal abundance and shifts in spatial distribution. Several important patterns emerge from this comprehensive analysis. First, comparisons of survey results between those collected in 2017–2018 and those collected during 2003–2009 suggest possible changes in the abundance and occurrence of some species. Overall, there appear to be decreases in both the number of species and number of individuals of small whale and oceanic delphinids in recent years. Most notably, there are reduced densities of pantropical spotted dolphins in recent years along with the other stenellid dolphins such as Clymene and spinner dolphins, which were relatively common in earlier surveys. Though it is difficult to interpret due to relatively high uncertainty, there was a general decline in abundance estimates for the “blackfish” species. The interpretation of these potential trends is complicated by the high uncertainty and long time between estimates, the potential for shifts in animal distribution, and changes in survey methods. Additional surveys are required to determine if these reflect true decreases in marine mammal populations in the NGOM. Second, the development of SDMs and exploration of the relationships between marine mammal density and oceanographic features highlight important dynamics. The early survey period (2003–2009) had relatively high surface water productivity in the northeastern GOM with surface waters dominated by anticyclonic eddies (i.e., negative SLA values). This was a region of high density of sperm whales and several species of stenellid dolphins. However, in the recent survey years, we found the GOM to be dominated by waters more heavily influenced by the Loop Current and Loop Current eddies with positive SLA values. In general, this resulted in reduced productivity in the northeastern GOM and an apparent shift in the distribution of some species into the western GOM. This was particularly evident for sperm whales and pantropical spotted dolphins. These findings highlight the importance of understanding the underlying dynamics in oceanographic conditions and the impacts on marine mammal spatial distribution and abundance.

The results from this study provide critical information and address uncertainties that are relevant and important to decision-making for multiple federal agencies, including the Department of Interior, Department of Defense, and NOAA. Each of the agencies requires current abundance estimates, and trends in abundance if available, for each GOM marine mammal species to understand and assess potential impacts of human activities. These assessments are further enhanced with high-quality spatial-density models that can be used to predict seasonal distribution and density of marine mammals and their relationship to the locations and timing of planned activities. Among other management uses, the new density models developed by this project provide critical data to BOEM and NOAA to inform analyses that support biological opinions, re-initiations, or step-down reviews of activities to determine if consultations are needed. For example, a recent GOM Biological Opinion on oil and gas exploration activities was based on vessel survey data from 2009 contained in NMFS stock assessments, and SDMs that were informed by these outdated data (e.g., Roberts et al. 2016). The products from the GoMMAPPS study offer a vast improvement over what was previously available. The study provides updated abundance estimates for 18 marine mammal taxa in oceanic waters, 7 stocks and/or species in continental shelf waters, and 1 BSE stock. In addition, the use of the two-team approach during aerial and large vessel surveys allowed us to reduce the biases in these abundance estimates for the first time for GOM stocks. These updated and less negatively biased abundance estimates have been incorporated into NMFS SARS to support decision-making for management.

Prior to this study, SDMs were developed for GOM species using past line-transect survey data in Roberts et al. (2016). These models used a similar suite of environmental variables and a similar spatial resolution to the current study. However, there have been several key improvements. First, the data entering the SDM were updated to the 2017–2018 surveys while the most recent data in the Roberts et al. models were from 2009. Second, the current study included direct estimation of perception and availability bias, while the Roberts et al. (2016) models used literature values derived from different survey areas and platforms as proxies. Finally, the previous model outputs represented long-term averages (“climatologies”) of marine mammal spatial distribution and density. In many cases, the models were also based on long-term average environmental conditions as opposed to contemporaneous conditions observed at the time of each survey (Roberts et al. 2016). The collection of more recent data, and the development of SDMs using contemporaneous variables, demonstrate the dynamic nature of the GOM and the responses of marine mammal species to these changing dynamics. We observed large scale shifts in both spatial distribution and abundance of marine mammals related to changes in physical oceanography. Capturing these dynamics and developing density predictions that reflect the current condition of the NGOM are therefore essential for assessing and mitigating impacts from human activities.

Further, the GoMMAPPS partnership between federal agencies streamlines the regulatory process by ensuring all agencies have access to the same best available data and products providing an excellent model for improved data collection and analyses for management into the future. Continuing these surveys will be important for providing updated data to keep abundance estimates current and to enhance the predictive model outputs with more certainty and fewer assumptions, leading to more precise management measures in the future. Also, planning for wind energy development projects is just beginning and the model outputs from this project are valuable tools in assessing the potential impacts of this new development.

Through the 2017–2021 GoMMAPPS study, 20 stock assessments were updated in the 2020 SARS and 6 stocks were updated in the 2021 SARS (Hayes et al. 2021; Hayes et al. 2022). The previous abundance estimates from the majority of these stocks were based upon survey data from 2009 and would have been considered outdated in the absence of the GoMMAPPS study. Timely, robust abundance estimates will remain a critical need for all GOM marine mammal species, and continuing surveys, such as the GoMMAPPS surveys, can meet this on-going need. Population sizes change over time and must be assessed at regular intervals to track these changes and understand whether populations are stable, increasing, or declining. For K-selected species with slow recovery times, it is important to observe declines early for effective management, and assessment surveys conducted at regular intervals maximize the ability to detect trends in a timely manner. This is particularly important for species impacted by large scale events, such as the DWH oil spill with its on-going impacts on GOM marine mammals and unusual mortality events. Maintaining ongoing surveys and integrating complementary datasets such as long-term moored passive acoustic monitoring programs are needed to capture the dynamics of these populations and to accurately estimate the impacts of anthropogenic activities.

It is also important to understand and be able to predict potential shifts in distribution particularly as those shifts relate to habitat variability. As part of the 2017–2021 GoMMAPPS work, we also developed seasonally and spatially explicit density models for 15 GOM marine mammal species or stocks, fulfilling critical management needs for predictive mapping of marine mammals for impacts analyses. Continuing surveys for up-to-date abundance and distribution information will provide additional data needed for model refinement to ensure predictive models for GOM marine mammals encompass the variety of oceanographic conditions these species experience to provide the best available science for environmental impact assessments. Considering the range of temporal scales over which oceanographic conditions vary (i.e., seasonal, inter-annual, interdecadal, etc.), predictive habitat models are best thought of as an iterative

process of model development and refinement as data are collected over longer time-scales that incorporate novel oceanographic conditions rather than as static products. This process of development and refinement ensures that our ability to predict marine mammal distribution and density is focused on the environmental features to which marine mammals are actively responding, particularly as we encounter previously unseen conditions.

One of the biggest data gaps is the lack of surveys in the southern GOM. Among the notable results from the analysis of trends in abundance over the last two decades was the high variability among years for species with sufficient data to make these comparisons. However, because all of the historic and current GoMMAPPS surveys have focused only on the US waters of the GOM, it is unknown whether this variability represents sampling variation, population size changes due to environmental or anthropogenic impacts, or movements of animals out of US waters. The projection of the SDMs into the southern GOM provides some insight into how species may move between the different regions; however, these projections are extremely uncertain in the absence of data. The GOM is a semi-enclosed basin that forms a Large Marine Ecosystem (Kumpf et al. 1999) that is relatively small with respect to large highly-mobile marine vertebrates such as marine mammals, and these animals, particularly populations inhabiting oceanic waters, should be assessed and managed from a basin-wide perspective. Yet there is a lack of data from non-US waters in the southern GOM (i.e., Mexico and Cuba), and US waters of the GOM comprise only 40% of the basin, limiting our ability to fully assess population status and trends. Long-term systematic surveys of all GOM waters are needed to evaluate and interpret inter-annual changes in distribution and abundance as this cannot be done reliably based on surveys of US waters alone.

Another notable result from the abundance trends analyses were the challenges in making inter-annual comparisons due to the relatively high CVs associated with the abundance estimates and the long period of time between abundance estimates. The high CVs found in this and previous surveys are primarily driven by relatively low sample sizes, as are common for marine mammal surveys, particularly for less common or deep diving species. Sample size could be increased, with associated decreases in uncertainty, by adding a second vessel to double survey coverage in US waters, or through expansion of surveys in concurrent years throughout the wider GOM. Alternatively, longer duration surveys or more regular surveys in the same season in consecutive years could provide the level of coverage needed to reduce uncertainty in abundance estimates. Much of the variability in design-based abundance estimates is due to underlying spatial variability in marine mammal encounter rates. The SDMs help to address some of this uncertainty as demonstrated by the lower CVs of abundance estimates derived from these models. Further development and application of advanced technologies, such as deploying gliders over sightings of unidentified species or those with large group sizes, could provide more accurate data and increase sample sizes of specific taxa. These advanced technologies have great potential to improve survey design and data quality, but require ground-truthing before they can be routinely applied. Additionally, the challenge of handling unidentified species sightings could be improved by incorporating acoustic classification information as additional evidence for assigning species ID to visually unidentified species. This requires further development of delphinid acoustic classification methods based on acoustic recordings associated with positively identified sightings. In some cases, alternative survey designs and methodologies may be required to improve abundance and abundance trend estimates. Of particular note, abundance surveys for the rare Rice's whale may require separate surveys with a specialized design that focuses line-transects on the shelf break throughout the GOM to obtain sufficient coverage and sample sizes needed for a rare and narrowly distributed species. Alternatively, mark-recapture photoID surveys may be appropriate for estimating population size for this rare species with some visually distinctive individuals.

The SDM models account for several known sources of bias and uncertainty; however, there remain additional potential biases that users should be aware of. First, the majority of the vessel survey data were collected during warm months of the year (generally April-October), and there was only one true winter survey. Weather conditions during this single survey were generally poor, and estimates of detection probability were less reliable. For species where sea surface temperature was a significant explanatory factor (e.g., sperm whales) the temperature effects are confounded with seasonal effects. Therefore, model predictions of lower densities in winter months may be influenced by both the relative paucity of data and the likely lower probability of detection during cold periods. Additional survey effort during winter months, which would allow season-specific estimates of detection probability, is needed to verify the predicted changes in seasonal density. Second, for the cryptic species (beaked whales and pygmy/dwarf sperm whales) it was not possible to directly estimate perception bias because there were too few sightings by both survey teams. For both taxa, we addressed some of this known negative bias. For beaked whales, dive-surface interval data was incorporated to address availability bias. For *Kogia* spp., restricting the analysis to survey effort with a sea state of two or less limits the effect of viewing conditions on detection probability. However, in both cases, there likely remains a degree of unquantified negative bias in the density estimates. For these relatively difficult to visually observe species, it is likely that integrating visual and acoustic data will be the best approach for quantifying and correcting for these biases. Finally, the treatment of unidentified taxa and spatially apportioning their density into the identified taxa addresses a known source of bias, but also makes several implicit assumptions that cannot be tested. In particular, we are assuming that the ability to reliably identify animals is the same across similar taxa, that group size estimates are equally reliable between identified and unidentified groups, and that detection probabilities do not vary among species. These assumptions cannot be directly tested. However, future surveys that integrate drone systems that could be used to identify distant groups and verify group sizes may be approaches that could reduce this source of uncertainty. Ongoing improvements in both survey and analytical methods and additional data collection will help refine the SDMs and improve their reliability.

The acoustic and visual abundance estimates for sperm whales were very similar for a given survey, but both methods have limitations. While the visual survey estimates account for perception bias, they do not account for availability on the trackline and are expected to be biased low. For the acoustic abundance estimates, there is potential for both availability bias and perception bias, but the size of this bias is unknown. Non-echolocating animals cannot be detected with this method; tagged sperm whales generally click throughout their deep dives, but are less acoustically active at the surface (Watwood et al. 2006) and those resting for extending periods of time at the surface are unlikely to be available to acoustics (Barlow and Taylor 2005). It also is unknown how often diving sperm whales are quiet, for example whether they eavesdrop like some delphinids (Götz et al. 2006). There may also be perception biases associated with this method, including lower detectability in areas with high noise levels and due to sound propagation conditions that may lead to shadow zones or that make it difficult to detect animals directly on the trackline. Sperm whale echolocation clicks are highly directional and it is unlikely that whales directly below the ship would be pointed up toward the surface; however, sperm whale clicks have very high source levels and off-axis clicks may still be detectable for whales on the trackline if there are no sound propagation shadow zones impacting detectability. The cause of the decreased detections near the trackline in this study is unknown and has the potential to bias abundance estimates low if there is a physical or biological reason that whales on the trackline cannot be detected, or if the whales are exhibiting vessel avoidance. Acoustic localizations with only two closely spaced hydrophones require that multiple bearings be obtained over time as the ship moves to get bearing crosses and a location, as opposed to the instantaneous localization from visual sightings. There is sufficient time for a whale to move during the localization process and this movement may impact the accuracy of the localization. Comparisons of acoustic localizations with visual detections, particularly for those click train events that

start or stop during the course of an encounter, will help to understand the biases associated with this method. A two-team capture-recapture method with the visual and acoustic teams may be feasible for improving abundance estimates since these two methods have complementary availability biases.

A key question about GOM marine mammals that was not addressed under the GoMMAPPS project is whether there is finer or coarser population stock structure for each species than is currently known. Beyond the MMPA requirement that marine mammals be assessed and managed as population stocks, understanding population stock structure is critical to ensuring human activities are neither under-regulated nor over-regulated, making this a key need for management across multiple federal agencies. Due to lack of data to address stock structure questions, management agencies currently assume that each cetacean species in GOM continental shelf waters (20–200 m) and oceanic waters (>200 m) constitutes one stock each for each habitat, and that these stocks are separate stocks from the same species inhabiting the adjacent Atlantic Ocean and Caribbean Sea. These assumptions have not been tested for most species and it remains unknown whether there are multiple intra-GOM stocks of the same species, and whether GOM stocks are truly distinct from the adjacent Atlantic and Caribbean stocks. A poignant example of the historical lack of understanding of taxonomic structure of GOM cetaceans is the recent discovery that GOM Bryde's whales were not only a distinct population, but a distinct, previously unrecognized species, now identified as the Rice's whale (Rosel et al. 2021). To properly assess and manage anthropogenic impacts on a stock-basis, it is critical that stocks be identified and accurately delineated. For example, if only one stock is defined for an area when in fact multiple stocks exist, a localized anthropogenic impact could seriously impact one stock and lead to population declines but this impact could be grossly underestimated by the combined stock abundance estimate (i.e., under-management). In shelf and oceanic waters of the GOM, only two of the cetacean species (common bottlenose dolphins and Atlantic spotted dolphins) have been examined for stock structure, and in both cases, significant partitioning of populations was identified (Viricel and Rosel 2014; Vollmer and Rosel 2017). Conversely, if a GOM stock is not genetically distinct from Caribbean or Atlantic stocks, impact assessment may overestimate the population level effects. A solid understanding of the stock structure of GOM marine mammals would ensure management occurs at the appropriate level, preventing potential population declines for species with greater stock structure than currently recognized and preventing potential over-regulation of activities impacting species with less stock structure than is currently recognized.

A variety of survey enhancements and development of survey and analytical methodologies could be implemented to improve our understanding of GOM marine mammal stock structure. To collect the data required to address stock structure questions, a routine biopsy sampling program of select species in the GOM needs to be implemented. Biopsy samples need to be collected in sufficient numbers and over a broad geographic area to address intra-GOM stock structure hypotheses, and when possible include samples from the Atlantic and Caribbean in analyses. Pantropical spotted dolphins are particularly amenable to genetic stock structure studies because of their abundance and broad distribution, and their propensity to bow ride, which allows for quick remote biopsy sampling during typical abundance surveys. In addition to genetic methods, techniques relying on satellite tagging, photo-identification, acoustics, and morphology can be used to augment information and help delimit stock structure, and these techniques can additionally provide important life-history and ecological information about a species that can improve their assessment and management. All of these techniques are also readily applicable to endangered sperm whales and Rice's whales, while a subset could be used with larger delphinids such as pilot whales, false killer whales, and killer whales.

The analysis of passive acoustic data from the current ship-based surveys to derive complimentary estimates of abundance for sperm whales demonstrates the potential for passive acoustic tools to improve abundance estimation, particularly for deep diving marine mammals. For towed array surveys, the acoustic abundance estimates and the visual abundance estimates reflect different groups of sperm

whales. The acoustic estimates primarily quantify animals that are underwater while visual estimates characterize those at the surface. There is a degree of overlap between these estimates as animals transition from the surface to below the surface and may be counted by both detection methods. Additional analyses are needed to evaluate this degree of overlap and develop a combined acoustic and visual estimate for sperm whales. This approach is likely to be especially valuable for beaked whales and the *Kogia* species that are difficult to assess using visual methods alone.

A program to implement long-term passive acoustic monitoring (PAM) of cetaceans throughout the GOM oceanic waters was recently begun with funding from NOAA's RESTORE Act Science Program and a DWH open ocean marine mammal restoration project to reduce noise impacts on marine mammals. In addition to multiple site-specific trends analyses, PAM data collected from moored PAM instruments deployed at sites in the US and Mexico GOM will be used to validate and further inform predictive habitat models developed during GoMMAPPS. Moored long-term PAM and broad-scale vessel-based surveys of oceanic waters provide complementary data with vessel-based surveys covering large spatial areas at a snapshot in time and moored PAM surveys covering relatively smaller spatial areas around each site over long periods of time. Also, visual surveys are most effective at sampling species that surface frequently and are easy to identify visually (e.g., delphinids) while acoustic surveys are most effective at detecting and estimating density of acoustically active marine mammals with highly distinctive acoustic signals and smaller group size (e.g., sperm whale species, beaked whale species). Further, development of moored PAM density estimation techniques is at the cutting edge of scientific knowledge and requires validation and tuning from more traditional survey techniques, such as vessel-based line-transect surveys. Together, these two survey techniques provide results that form a solid foundational understanding of marine mammal abundance and spatial density over the temporal and spatial scales required for protected and endangered species management, conservation, and restoration. Though the PAM work is currently funded from 2020 to 2024, additional vessel and aerial surveys are not and we may miss an opportunity to leverage and pair these two important techniques, further highlighting the need to establish a consistent, regular vessel and aerial-based survey program in the GOM.

In summary, the 2017–2021 GoMMAPPS program has yielded current abundance estimates and updated stock assessments for 26 GOM marine mammal stocks and seasonal spatial-density models for 15 marine mammal species and four sea turtle species that provide a tool for assessing and managing human impacts on protected and endangered species. Historically, a lack of (1) long-term, routine surveys with standardized methods at consistent intervals, (2) GOM-wide spatial coverage, and (3) seasonal data particularly from spring, winter, and fall, severely limited the ability to assess marine mammal species' abundance and population status, predict seasonal and inter-annual spatial distribution, and assess impacts from managed human activities. The cross-agency GoMMAPPS collaboration has substantially improved the ability to assess and manage protected and endangered marine mammal species in the GOM bringing stock assessments up to date for all NGOM marine mammal species and providing the crucial information needed to predict potential impacts. The continuation of these robust surveys at regular intervals, ideally with expansion to a GOM-wide assessment program, will help to ensure that management and regulatory decisions are based upon current, precise, and accurate information on marine mammal population status.

References

- [DWH MMIQT] Deepwater Horizon Marine Mammal Injury Quantification Team. 2015. Models and analyses for the quantification of injury to Gulf of Mexico cetaceans from the *Deepwater Horizon* oil spill, MM_TR.01_Schwacke_Quantification.of.Injury.to.GOM.Cetaceans. 64 p. [accessed 5 June 2023]; <https://www.fws.gov/doiddata/dwh-ar-documents/876/DWH-AR0105866.pdf>
- Barlow J. 1995. The abundance of cetaceans in California waters. Part I: ship surveys in summer and fall of 1991. *Fish Bull.* 93(1):1–14.
- Barlow J, Taylor BL. 2005. Estimates of sperm whale abundance in the northeastern temperate Pacific from a combined acoustic and visual survey. *Mar Mammal Sci.* 21(3):429–445.
- Becker EA, Foley DG, Forney KA, Barlow J, Redfern JV, Gentemann CL. 2012. Forecasting cetacean abundance patterns to enhance management decisions. *Endang Species Res.* 16:97–112. doi:10.3354/esr00390.
- Becker JJ, Sandwell DT, Smith WHF, Braud J, Binder B, Depner J, Fabre D, Factor J, Ingalls S, Kim S-H, et al. 2009. Global bathymetry and elevation data at 30 arc seconds resolution: SRTM30_PLUS. *Mar Geod.* 32(4):355–371. doi:10.1080/01490410903297766.
- Best BD, Halpin PN, Read AJ, Fujioka E, Good CP, LaBrecque EA, Schick RS, Roberts JJ, Hazen LJ, Qian SS, et al. 2012. Online cetacean habitat modeling system for the US East Coast and Gulf of Mexico. *Endang Species Res.* 18:1–15. doi:10.3354/esr00430.
- Blaylock RA, Hoggard W. 1994. Preliminary estimates of bottlenose dolphin abundance in southern U.S. Atlantic and Gulf of Mexico continental shelf waters. Miami (FL): National Marine Fisheries Service, Southeast Fisheries Science Center. NOAA Technical Memorandum NMFS-SEFSC-356. <https://repository.library.noaa.gov/view/noaa/8534>.
- Buckland ST, Anderson DR, Burnham KP, Laake JL. 2005. Distance sampling. In: Armitage P, Colton T, editors. *Encyclopedia of Biostatistics*. Chichester (GB): John Wiley & Sons, Ltd. <http://doi.wiley.com/10.1002/0470011815.b2a16019>.
- Buckland ST, Anderson DR, Burnham KP, Laake JL, Borchers DL, Thomas L. 2001. *Introduction to distance sampling: estimating abundance of biological populations*. Oxford (GB): Oxford University Press.
- Fertl D, Schiro AJ, Regan GT, Beck CA, Adimey N, Price-May L, Amos A, Worthy GAJ, Crossland R. 2005. Manatee occurrence in the northern Gulf of Mexico, west of Florida. *Gulf Caribb Res.* 17(1):69–94. doi:10.18785/gcr.1701.07.
- Fritts T, Irvine A, Jennings R, Collum L, Hoffman W, McGehee M. 1983. *Turtles, birds, and mammals in the northern Gulf of Mexico and nearby Atlantic waters: an overview based on aerial surveys of OCS areas, with emphasis on oil and gas effects*. Washington (DC): US Fish and Wildlife Service, Division of Biological Services. FWS/OBS-82.65. 455 p.
- Fulling GL, Mullin KD, Hubard CW. 2003. Abundance and distribution of cetaceans in outer continental shelf waters of the U.S. Gulf of Mexico. *Fish Bull.* 101(4):923–932.

- Garrison LP. 2016. Abundance of marine mammals in waters of the U.S. Gulf of Mexico during summer 2009. PRD Contribution: #PRD-2016-09. Miami (FL): Southeast Fisheries Science Center. 18 p.
- Garrison LP. 2017. Abundance of coastal and continental shelf stocks of bottlenose dolphins in the northern Gulf of Mexico: 2011-2012. PRD Contribution: #PRD-2017-04. Miami (FL): Southeast Fisheries Science Center. 17 p.
- Garrison LP, Martinez A, Maze-Foley K. 2010. Habitat and abundance of cetaceans in Atlantic Ocean continental slope waters off the eastern USA. *J Cetacean Res Manag.* 11(3):267–277.
- Garrison LP, Ortega-Ortiz J, Rappucci G. 2020. Abundance of marine mammals in waters of the U.S. Gulf of Mexico during the summers of 2017 and 2018. PRD Contribution: #PRD-2020-07. Miami (FL): Southeast Fisheries Science Center. 56 p. doi:10.25923/3px6-9v48.
- Garrison LP, Ortega-Ortiz J, Rappucci G. 2021. Abundance of coastal and continental shelf stocks of common bottlenose and Atlantic spotted dolphins in the northern Gulf of Mexico: 2017-2018. PRD Contribution: #PRD-2021-01. Miami (FL): Southeast Fisheries Science Center. 25 p. doi:10.25923/vk95-t881.
- Garrison LP, Ortega-Ortiz J, Rappucci G. 2022. Abundance of sea turtles in the northern Gulf of Mexico from aerial line transect surveys. MMTD Contribution: #MMTD-2022-03. Miami (FL): Southeast Fisheries Science Center. 44 p.
- Gillespie D, Mellinger DK, Gordon J, McLaren D, Redmond P, McHugh R, Trinder PW, Deng XY, Thode A. 2008. PAMGUARD: semiautomated, open source software for real-time acoustic detection and localisation of cetaceans. In: Proceedings of the Conference on Underwater Noise Measurement: Impact and Mitigation 2008, Southampton, GB, 14-15 Oct 2008. Red Hook (NY). Proceedings of the Institute of Acoustics: Curan Associates. p. 54–62.
- Götz T, Verfuß UK, Schnitzler H-U. 2006. “Eavesdropping” in wild rough-toothed dolphins (*Steno bredanensis*)? *Biol Lett.* 2(1):5–7. doi:10.1098/rsbl.2005.0407.
- Hansen LJ, Mullin KD, Jefferson TA, Scott GP. 1996. Visual surveys aboard ships and aircraft. In: Davis RW, Fargion GS, editors. Distribution and abundance of marine mammals in the north-central and western Gulf of Mexico: final report. Volume II: technical report. New Orleans (LA): US Department of the Interior, Minerals Management Service. Obligation Nos.: 14-35-0001-30619; Interagency Agreement 16197. Report No.: MMS 96-0027. 380 p. p. 55–132.
- Hansen LJ, Mullin KD, Roden CL. 1995. Estimates of cetacean abundance in the northern Gulf of Mexico from vessel surveys. Contribution No. MIA-94/95-25. Miami (FL): Southeast Fisheries Science Center. 19 p. <https://repository.library.noaa.gov/view/noaa/9089>.
- Harris PT, Macmillan-Lawler M, Rupp J, Baker EK. 2014. Geomorphology of the oceans. *Mar Geol.* 352:4–24. doi:10.1016/j.margeo.2014.01.011.
- Hayes SA, Josephson E, Maze-Foley K, Rosel PE, Turek J, editors. 2021. US Atlantic and Gulf of Mexico Marine Mammal Stock Assessments 2020. Woods Hole (MA): National Marine Fisheries Service. Report No.: NOAA Technical Memorandum NMFS-NE-271. 403 p. doi:10.25923/nbyx-p656.

- Hayes SA, Josephson E, Maze-Foley K, Rosel PE, Wallace J, editors. 2022. U.S. Atlantic and Gulf of Mexico Marine Mammal Stock Assessments 2021. Woods Hole (MA): National Marine Fisheries Service. Report No.: NOAA Technical Memorandum NMFS-NE-288. 387 p. doi:10.25923/6tt7-kc16.
- Hieb EE, Carmichael RH, Aven A, Nelson-Seely C, Taylor N. 2017. Sighting demographics of the West Indian manatee *Trichechus manatus* in the north-central Gulf of Mexico supported by citizen-sourced data. *Endang Species Res.* 32:321–332. doi:10.3354/esr00817.
- Holm S. 1979. A simple sequentially rejective multiple test procedure. *Scand J Stat.* 6(2):65–70.
- Kumpf H, Steidinger KA, Sherman KE. 1999. The Gulf of Mexico large marine ecosystem: assessment, sustainability, and management. Malden (MA): Blackwell Science. 704 p.
- Laake J, Borchers D, Thomas L, Miller D, Bishop J. 2020. mrds: mark-recapture distance sampling. R package version 2.2.1. <https://cran.r-project.org/package=mrds>.
- Laake JL, Borchers DL. 2004. Methods for incomplete detection at distance zero. In: Buckland ST, Anderson DR, Burnham KP, Laake JL, Borchers DL, Thomas L, editors. *Advanced distance sampling*. New York (NY): Oxford University Press. p. 108–189.
- Laake JL, Calambokidis J, Osmek SD, Rugh DJ. 1997. Probability of detecting harbor porpoise from aerial surveys: estimating $g(0)$. *J Wildl Manag.* 61(1):63–75.
- Marsh H, Sinclair DF. 1989. Correcting for visibility bias in strip transect aerial surveys of aquatic fauna. *J Wildl Manag.* 53(4):1017–1024.
- Maze-Foley K, Mullin KD. 2006. Cetaceans of the oceanic northern Gulf of Mexico: distributions, group sizes and interspecific associations. *J Cetacean Res Manag.* 8(2):203–213.
- Mellinger DK. 2001. *Ishmael 1.0 user's guide*. NOAA Technical Memorandum OAR PMEL-120. Available from: from NOAA/PMEL/OERD, 2115 SE OSU Drive, Newport, OR 97365-5258.
- Miller BS, Barlow J, Calderan S, Collins K, Leaper R, Olson P, Ensor P, Peel D, Donnelly D, Andrews-Goff V, et al. 2015. Validating the reliability of passive acoustic localisation: a novel method for encountering rare and remote Antarctic blue whales. *Endang Species Res.* 26:257–269. doi:10.3354/esr00642.
- Miller DL, Burt ML, Rexstad EA, Thomas L. 2013. Spatial models for distance sampling data: recent developments and future directions. *Methods Ecol Evol.* 4(11):1001–1010. doi:10.1111/2041-210X.12105.
- Mullin KD. 2007. Abundance of cetaceans in the oceanic northern Gulf of Mexico from 2003 and 2004 ship surveys. Southeast Fisheries Science Center reference document PRBD 2016-03. Pascagoula (MS): Southeast Fisheries Science Center. 27 p. doi:10.7289/V5/RD-PRBD-2016-03.
- Mullin KD, Fulling GL. 2003. Abundance of cetaceans in the southern U.S. North Atlantic Ocean during summer 1998. *Fish Bull.* 101(3):603–613.

- Mullin KD, Fulling GL. 2004. Abundance of cetaceans in the ocean northern Gulf of Mexico, 1996-2001. *Mar Mammal Sci.* 20(4):787–807.
- Mullin KD, Hoggard W. 2000. Visual surveys of cetaceans and sea turtles from aircraft and ships. In: Davis RW, Evans WB, Würsig B, editors. *Cetaceans, sea turtles and seabirds in the northern Gulf of Mexico: distribution, abundance and habitat associations. Volume II: technical report.* New Orleans (LA): US Department of the Interior, Minerals Management Service. 363 p. Report No.: USGS/BED/CR-1999-0006 and MMS 2000-003. p. 111-172.
- Mullin KD, Lohoefer RR, Hoggard W, Roden CL, Rogers CM. 1990. Abundance of bottlenose dolphins, *Tursiops truncatus*, in the coastal Gulf of Mexico. *Northeast Gulf Sci.* 11(2):113–122. doi:10.18785/negs.1102.03. [accessed 2020 Jun 18]. <https://aquila.usm.edu/goms/vol11/iss2/3>.
- R Core Team. 2020. R: a language and environment for statistical computing. Vienna, AT. <https://www.r-project.org/>.
- Rankin S, Barlow J, Barkley Y, Valtierra R. 2013. A guide to constructing hydrophone arrays for passive acoustic data collection during NMFS shipboard cetacean surveys. La Jolla (CA): National Marine Fisheries Service. Report No.: NOAA-TM-NMFS-SWFSC-511. 36 p.
- Roberts JJ, Best BD, Mannocci L, Fujioka E, Halpin PN, Palka DL, Garrison LP, Mullin KD, Cole TVN, Khan CB, et al. 2016. Habitat-based cetacean density models for the U.S. Atlantic and Gulf of Mexico. *Sci Rep.* 6(22615). doi:10.1038/srep22615.
- Roberts KE, Garrison LP, Ortega-Ortiz J, Hu C, Zhang Y, Sasso CR, Lamont M, Hart KM. 2022. The influence of satellite-derived environmental and oceanographic parameters on marine turtle time at surface in the Gulf of Mexico. *Remote Sens.* 14(18):4534. doi:10.3390/rs14184534.
- Rosel PE, Wilcox LA. 2014. Genetic evidence reveals a unique lineage of Bryde’s whales in the northern Gulf of Mexico. *Endang Species Res.* 25:19–34. doi:10.3354/esr00606.
- Rosel PE, Wilcox LA, Yamada TK, Mullin KD. 2021. A new species of baleen whale (*Balaenoptera*) from the Gulf of Mexico, with a review of its geographic distribution. *Mar Mammal Sci.* 37:577–610. doi:10.1111/mms.12776.
- Scott GP, Burn DM, Hansen LJ, Owen RE. 1989. Estimates of bottlenose dolphin abundance in the Gulf of Mexico from regional aerial surveys. CRD-88/89-07. Available from: NMFS, Southeast Fisheries Science Center, 75 Virginia Beach Dr., Miami, FL 33149.
- Thomas L, Buckland ST, Rexstad EA, Laake JL, Strindberg S, Hedley SL, Bishop JRB, Marques TA, Burnham KP. 2010. Distance software: design and analysis of distance sampling surveys for estimating population size. *J Appl Ecol.* 47(1):5–14. doi:10.1111/j.1365-2664.2009.01737.x.
- Valverde RA, Holzward KR. 2017. Sea turtles of the Gulf of Mexico. In: Ward C, editor. *Habitats and biota of the Gulf of Mexico: before the Deepwater Horizon oil spill, volume I: water quality, sediments, sediment contaminants, oil and gas seeps, coastal habitats, offshore plankton and benthos, and shellfish.* New York (NY): Springer. p. 917. p. 33-37.
- Viricel A, Rosel PE. 2014. Hierarchical population structure and habitat differences in a highly mobile

- marine species: The Atlantic spotted dolphin. *Mol Ecol.* 23(20):5018–5035. doi:10.1111/mec.12923.
- Vollmer NL, Rosel PE. 2017. Fine-scale population structure of common bottlenose dolphins (*Tursiops truncatus*) in offshore and coastal waters of the US Gulf of Mexico. *Mar Biol.* 164(160). doi:10.1007/s00227-017-3186-x.
- Waring GT, Josephson E, Maze-Foley K, Rosel PE, editors. 2016. US Atlantic and Gulf of Mexico marine mammal stock assessments - 2015. Woods Hole (MA): National Marine Fisheries Service. 512 p. Report No.: NOAA Technical Memorandum NMFS-NE-238. doi:10.7289/V57S7KTN.
- Watwood SL, Miller PJO, Johnson M, Madsen PT, Tyack PL. 2006. Deep-diving foraging behaviour of sperm whales (*Physeter macrocephalus*). *J Anim Ecol.* 75(3):814–825. doi:10.1111/j.1365-2656.2006.01101.x.
- Wessel P, Smith WHF. 1996. A global, self-consistent, hierarchical, high-resolution shoreline database. *J Geophys Res Solid Earth.* 101(B4):8741–8743.
- White D, Kimerling JA, Overton SW. 1992. Cartographic and geometric components of a global sampling design for environmental monitoring. *Cart Geogr Inf.* 19(1):5–22. doi:10.1559/152304092783786636.
- Würsig B, Jefferson TA, Schmidly DJ. 2000. The marine mammals of the Gulf of Mexico. College Station (TX): Texas A&M University Press. 256 p.

Appendix A: Data Auditing Protocols

Contents

A.1	Aerial Survey Data Auditing Protocol	75
A.1.1	Error Log Table	75
A.1.2	Survey Track Table	75
A.1.3	Sightings Table.....	76
A.1.4	Non-Mammal Sightings Table.....	77
A.1.5	Sighting Marks Table	78
A.1.6	Marine Mammal Behavioral Log Table	78
A.1.7	Other Data Considerations.....	78
A.2	Cruise Survey Data Auditing Protocol.....	78
A.2.1	Visual Survey Database.....	79
A.2.1.1	Error Log Table	79
A.2.1.2	Survey Track Table	79
A.2.1.3	Sightings Table.....	80
A.2.1.4	Cues Table	80
A.2.1.5	Non-Mammal Sightings Table.....	80
A.2.2	Sight Sheet Database	80
A.2.2.1	Group Size Table	80
A.2.2.2	Sighting Sheet Table.....	80
A.2.2.3	Other Data Considerations.....	81

A.1 Aerial Survey Data Auditing Protocol

Data managers follow standardized protocols for auditing data collected during SEFSC surveys. The protocol below lists steps applied to data collected during the GoMMAPPS surveys. This is a living document and data managers add new procedures on a needed basis (e.g. to address particular aspects of each survey).

Before delivering the final data to the data manager, the field party chief (FPC) checks for misidentification in species for sightings for which photos were taken and communicates that to the data manager, who will make corrections as needed.

The data manager maintains a copy of all original data provided by the FPC as is and makes edits and corrections on copies of the original files. The auditing steps listed in this protocol are applied to the data tables in the visual sighting Microsoft® Access database for both teams (T1 = team 1, forward and T2 = team 2, aft).

A.1.1 Error Log Table

- 1- Review the error log for both teams and make necessary edits: the data manager creates a column in the “Errors” table named “Edits_INITIALS” and notes the changes needed or if no action is required, writes “None”. For changes in data, use the index numbers from each table to reference the correction. For example, changes in the Survey Track table are logged beginning with “Index ###:”; Sightings table “MammalIndex ##:”; NonMammalSightings table “OtherIndex ##: ”, and so on.
- 2- Add extraordinary auditing notes and procedures per AuditingCodes (Table A.1-1).

A.1.2 Survey Track Table

- 1- Delete test entry points.
- 2- Verify that transit lines have the same naming convention (“transit” and not variations like “TRANSIT” or “Transit”).
- 3- Verify that all transit points are off effort.
- 4- Create a column in the SurveyTrack tables labeled AuditingCode (see Table A.1-1).
- 5- Make sure there is no belly observer for T1 and left observer for T2 while on effort. If stated otherwise, flag the 1st record available with AuditingCode 111 (see Table A.1-1).
- 6- Verify that positions are not Unoccupied (-9) during effort according to team (T1: left, right and recorder; T2: right, belly, and recorder).
- 7- Make sure environmental data were updated whenever observers went on effort. As necessary, backfill any rows with 0 values with data from the following point.
- 8- Verify that there are no tracklines assigned with identical numbers on different survey days. If repeated, assign a new numeric unique identifier.
- 9- Remove unused columns (Water Temperature and OnTransect) from the table.

Once the SurveyTrack table is imported into ArcGIS:

- 10- Verify there are no points plotting outside of the study area.
- 11- Verify that there are no transit points located within a numbered trackline, unless stated that that segment is actually transit and is off effort. If on effort points assigned to transit are within a

trackline, assign the trackline number from the nearest immediate points or a unique trackline identifier to those points.

12- Verify that no circling points are on effort.

13- Flag points outside of ideal ranges per Table A.1-1.

Table A.1-1 Codes used to flag points outside the ideal survey ranges

AuditingCode	Description	Method
100	Angular deviations on the survey trackline in relation to the proposed trackline	Visual inspection of map
101	Speed over ground below survey ideal	[OnEffort] = -1 AND [Speed] <96
102	Speed over ground above survey ideal	[OnEffort] = -1 AND [Speed] >111
103	GPS Altitude below survey ideal	[OnEffort] = -1 AND [GPSAltitude] <175
104	GPS Altitude above survey ideal	[OnEffort] = -1 AND [GPSAltitude] >196
105	Speed over ground and GPS Altitude below survey ideal	[OnEffort] = -1 AND ([Speed] <96 AND [GPSAltitude] <175)
106	Speed over ground below and GPS Altitude above survey ideal	[OnEffort] = -1 AND ([Speed] <96 AND [GPSAltitude] >196)
107	Speed over ground and GPS Altitude above survey ideal	[OnEffort] = -1 AND ([Speed] >111 AND [GPSAltitude] >196)
108	Speed over ground above and GPS Altitude below survey ideal	[OnEffort] = -1 AND ([Speed] >111 AND [GPSAltitude] <175)
109	A change was made in the records during data auditing	Note in Error Log
110	Record with issue unresolved	Note in Error Log
111	Additional information about record	Note in Error Log

A.1.3 Sightings Table

- 1- Make sure the number of mammal sightings between T1 and T2 are the same, unless stated otherwise.
- 2- Delete test entry sightings.
- 3- Compare T1 and T2 sighting data on the following fields: date, sighting number, entry time and coordinates, species, group size, calves and transect number. Values for date, sighting number, species, group sizes, calves, and transect should be the same; values for time and coordinates should be relatively close (usually less than 2 minutes and 2 kilometers).
- 4- Create a column in the Sightings tables labeled AuditingCode.
- 5- Make sure SightingPosition values make sense by team, effort and has complete data (Table A.1-2, Table A.1-3).

Table A.1-2 Data auditing checks for SightingPosition

SightingPosition (Sights and NonMM tables)	Location of the observer at the moment of the sighting	Team	Effort**	Angle data	Belly increment data	Observer
1	Left bubble only	1 only	On	Yes	Blank	BubbleObs
2	Right bubble only	1 and 2	On	Yes	Blank	BubbleObs
3	Belly only	2 only*	On	Blank	Yes	BellyObs
4	Left bubble and belly	2 only*	On	Yes	Yes	BubbleObs + BellyObs
5	Right bubble and belly	2 only*	On	Yes	Yes	BubbleObs + BellyObs
6	Other	1 and 2	Off	No	No	99
7	Missed by either team	1 and 2	Off	Blank	Blank	99

* Belly positions can be located in T1 tables if the surveys was flown with 4 observers (left, right, belly, and data recorder).

** Effort should be on for most sightings unless stated otherwise in sighting sheets or error log, or if sighting was seen during transit. Flag with AuditingCode 109 (a change was made during auditing) if updating effort status.

Table A.1-3 Potential SightingPosition data discrepancies and outcomes

SightingPosition	Data issue	Outcome	AuditingCode
1 or 2	No angle	Make sighting off effort	109
3	No belly increment (NA)	Make sighting off effort	109
3	Belly increment NA but has angle	Change sighting position to 2 (T2)	109
3	Angle AND belly increment	Change sighting position to 5 and add BubbleObs	109
4 or 5	No angle data but have belly increment	Change sighting position to 3	109
4 or 5	No angle data and no belly increment	Make sighting off effort	109
4	Belly increment on R	Flag with AuditingCode and note on error log.	110
5	Belly increment on L and positive angle	Flag with AuditingCode and note on error log.	110

- 6- Make sure values in the Transect column are correct against SurveyTrack so that actual transit sightings are off effort.
- 7- Remove unused columns (EntryTemperature).

A.1.4 Non-Mammal Sightings Table

- 1- Delete test entry sightings.
- 2- Make sure SightingPosition values make sense by team, effort and has complete data (same procedures as for Sightings above). Sightings may be off effort if seen while circling for a mammal sighting.
- 3- Remove unused columns (EntryTemperature and Transect).

A.1.5 Sighting Marks Table

- 1- Import marks and sightings (from Sighting table) into ArcGIS.
- 2- Verify that marks (MammalIndex) are linked to the correct sightings via SightingIndex by location. Marks and associated sightings should plot near each other. Sightings that have been linked to the incorrect mark plot way off. Also, angles are the same between sighting and mark.
- 3- If a discrepancy in side is detected between the mark and the sighting (unless the angle is negative), use additional information to determine which side is correct (Table A.1-4).

Table A.1-4 Potential data discrepancies between Sightings and Marks tables

Mark side (Pos)	Sighting side (SightingPos)	Detection	Outcome
Left (0)	Right bubble (2)	Both teams and/or T2 on right	Correct mark to right (1), Auditing code 109
Left (0)	Right bubble (2)	T1 only	Auditing code 110 (unresolved)
Left (0)	Right bubble (2)	T2 only	Correct mark to right (1), Auditing code 109
Left (0)	Right bubble (2)	Both teams but one team's angle is negative	Auditing code 110 (unresolved)
Right (1)	Left bubble (1)	Both teams and T2 on right (2 or 5)	Correct sight pos to right (2), Auditing code 109
Right (1)	Left bubble (1)	Both teams and T2 on right (2 or 5) but belly increment on left	Auditing code 110 (unresolved)
Right (1)	Left bubble (1)	T1 only	Auditing code 110 (unresolved)
Belly (2)	Right bubble (2) but no angle	T2 only	Correct sight pos to belly (3), Auditing code 109

A.1.6 Marine Mammal Behavioral Log Table

- 1- Transcribe mammal sighting behavior from the paper or digital files into the database.

A.1.7 Other Data Considerations

- 1- The same time zone is maintained throughout the survey even during daylight savings changes.
- 2- Database versioning is maintained by adding dates when edits were performed to the file name.
- 3- Data dictionaries with the meaning of numeric values used in the database are incorporated as separate tables into the database.
- 4- Data in the sighting sheets takes precedence over data in the database, unless stated otherwise in the Error Log.

A.2 Cruise Survey Data Auditing Protocol

Data managers follow standardized protocols for auditing data collected during SEFSC surveys. The protocol below lists steps applied to data collected during the GoMMAPPS surveys. This is a living document and data managers add new procedures on a needed basis (e.g. to address particular aspects of each survey).

The data manager onboard the ship performs minimal auditing on the data, mostly to ensure completeness by detecting fields inadvertently left blank and inconsistencies. For the marine mammal visual data, two

Microsoft® Access databases are created: one containing the sighting sheet data transcribed from the paper form by each observer and the visual survey data. Periodically, the data manager checks for inconsistencies in the data from the two databases in date, sighting number, species, observer name and effort status. If an inconsistency is detected, the paper sighting sheet is used as a reference to correct the data.

The data manager on land maintains a copy of all original data provided by the field party chief (FPC) as is and makes edits and corrections on copies of the original files. The auditing steps listed in this protocol are applied to the data tables in the visual sighting Microsoft® Access databases.

A.2.1 Visual Survey Database

A.2.1.1 Error Log Table

- 1- The data manager reviews the error log within the visual program and makes the necessary edits. On the error log table the data manager adds a column “Edits_INI” (data manager initials) and notes the edits made, including the unique index number of the field changed; if no change is needed, “None” is written. For changes in data, use the index numbers from each table to reference the correction. For example, changes in the Survey Track table are logged beginning with “Index ###: corrected from”; Sightings table “SightingIndex ##:”; NonMammalSightings table “NonMamIndex ##: ” and so on.
- 2- Add extraordinary auditing notes and procedures per AuditingCodes (Table A.2-1).

A.2.1.2 Survey Track Table

1. Delete test entry points and 0 coordinates.
2. Verify that there are no tracklines assigned with identical numbers on different survey days. If repeated, assign a new numeric unique identifier. Change any tracklines named “transit” to 999.
3. Make sure environmental data were updated whenever observers went on effort. As necessary, backfill any rows with 0 values with data from the following point.
4. Make sure all observers assigned to on effort points were actually on duty.
5. Make sure the point (RecType B) in Survey Track is on effort for on effort sightings.

Once the SurveyTrack table is imported into ArcGIS:

6. Verify there are no points plotting outside of the study area.
7. Make sure turns into new tracklines are off effort.
8. Flag points outside of ideal ranges per Table A.2-1.

Table A.2-1 Codes used to flag points outside the ideal survey ranges

AuditingCode	Description	Method
101	Speed over ground below survey ideal	[OnEffort1] = -1 AND [VessSpeed] <7.99 [OnEffort2] = -1 AND [VessSpeed] <7.99
102	Speed over ground above survey ideal	[OnEffort1] = -1 AND [VessSpeed] >12 [OnEffort2] = -1 AND [VessSpeed] >12
103	Angular deviations on the survey trackline in relation to the proposed trackline	Visual inspection of map
109	A change was made in the records during data auditing	Note in Error Log
110	Record with issue unresolved	Note in Error Log
111	Additional information about record	Note in Error Log

A.2.1.3 Sightings Table

- 1- Double check that sightings are single or double detections and verify data correspond.
- 2- Delete unused columns (EntryDepth and EntryTemperature).

A.2.1.4 Cues Table

- 1- Delete any test cues.
- 2- Verify effort status matches between cue and sighting
- 3- Verify CueTeam, ObsStation, ObsCode match with data in SurveyTrack and Sightings tables.
- 4- Make sure distance value makes sense with DistUnit (e.g. distances above 50 are likely in meters, if recorded as reticle, change to M). Log these changes in the error log (AuditingCode 111).

A.2.1.5 Non-Mammal Sightings Table

- 1- Delete any test sightings.
- 2- Make sure distance value makes sense with DistUnit (e.g. distances above 50 are likely in meters, if recorded as reticle, change to M). Log these changes in the error log (AuditingCode 111).
- 3- If Number is blank and EstNumber is 0, default Number to 1. If EstNumber has value (other than 0) leave Number as is. Log changes in Number in error log (AuditingCode 111).

A.2.2 Sight Sheet Database

A.2.2.1 Group Size Table

- 1- At least one entry is required per sighting.
- 2- Verify date and species match data in the visual survey database.
- 3- Values entered by observers are not audited themselves but verified that make sense (min ≤ best ≤ max).

A.2.2.2 Sighting Sheet Table

- 1- Make sure data match with the handwritten sighting sheets.

- 2- Confirm the presence of calves is correctly captured in the Sightings table and in the Visual survey database.
- 3- Make sure media for sheets checked “Yes” if photos and/or video taken.

A.2.2.3 Other Data Considerations

- 1- The same time zone is maintained throughout the survey even during daylight savings changes.
- 2- Database versioning is maintained by adding dates when edits were performed to the file name.
- 3- Data dictionaries with the meaning of numeric values used in the database are incorporated as separate tables into the database.
- 4- Data in the sighting sheets takes precedence over data in the database, unless stated otherwise in the Error Log.
- 5- Environmental data in SurveyTrack table collected via Ship Computer System (SCS) are not audited.
- 6- Incorporated Sighting Sheet database into the Visual Survey database.

Appendix B. Acoustic Setup Diagrams

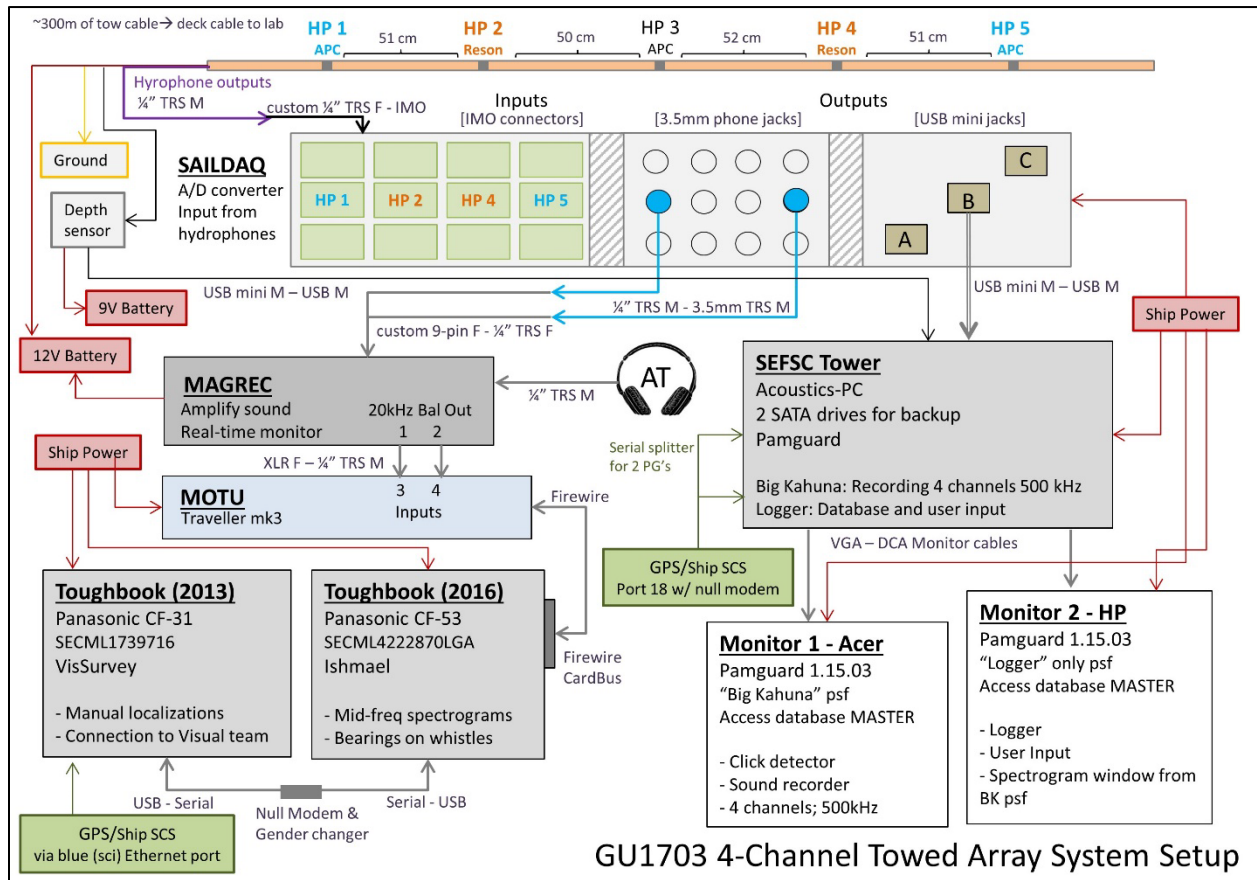
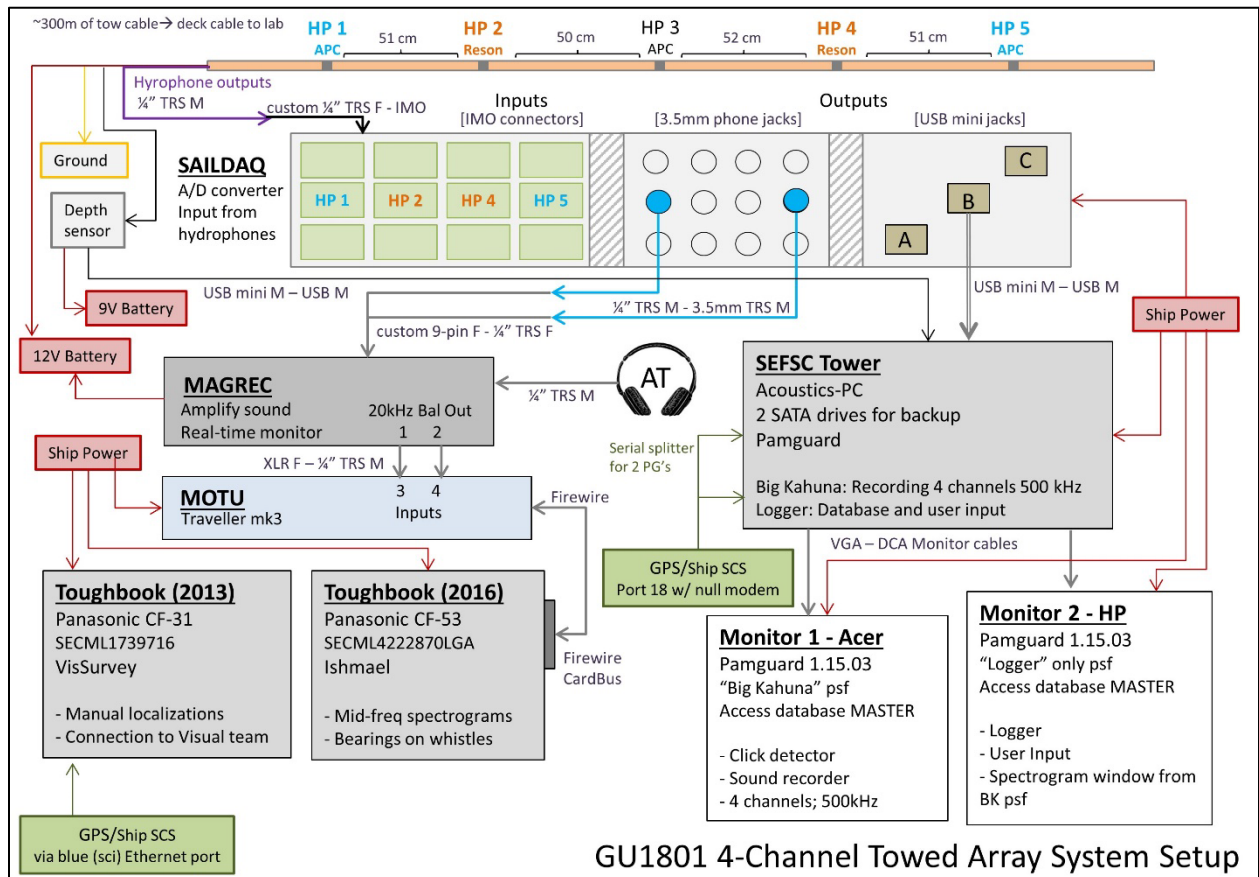

Figure B-1. Diagram of 4-channel towed array setup used during the summer 2017 GoMMAPPS vessel survey.



GU1801 4-Channel Towed Array System Setup

Figure B-2. Diagram of towed array setup used during the winter 2018 GoMMAPPS vessel survey.

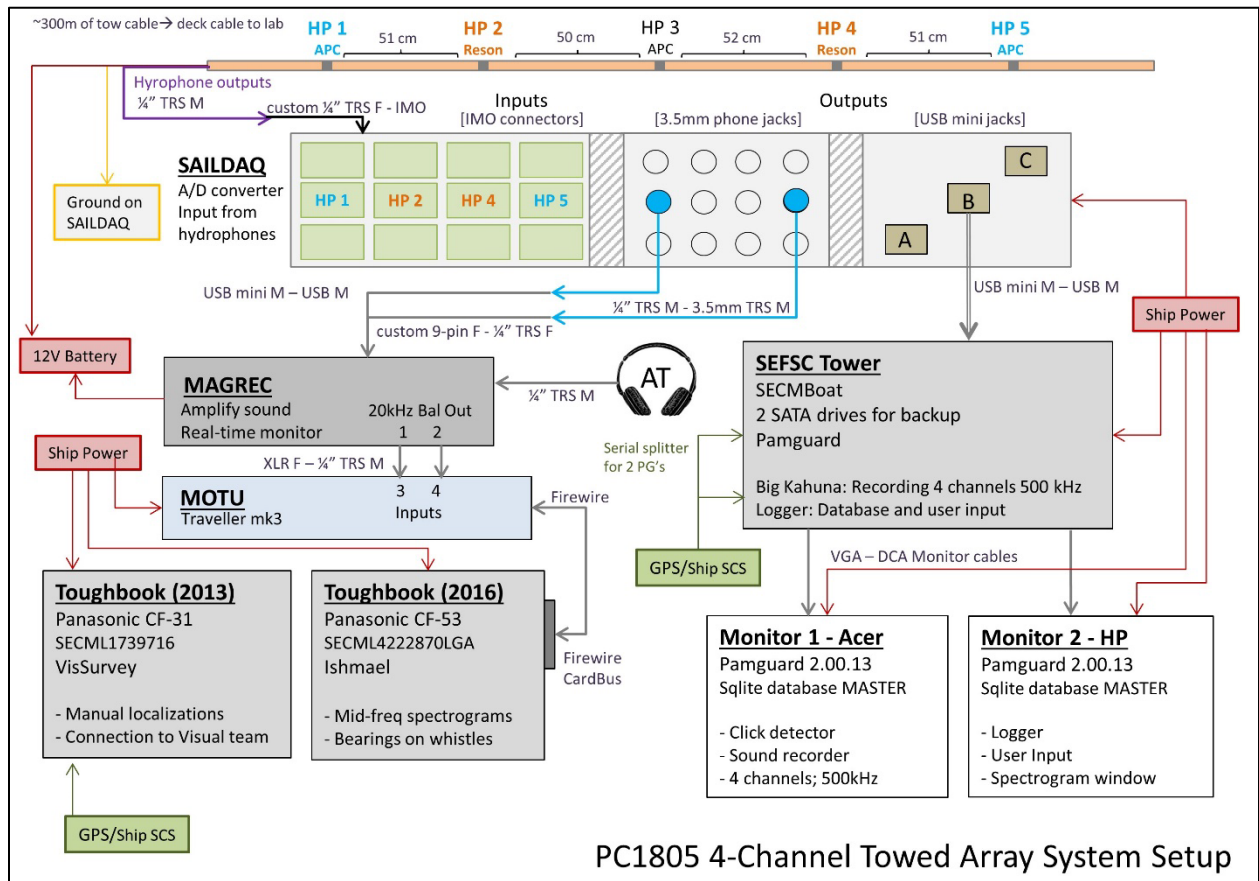

Figure B-3. Diagram of towed array setup used during the summer/fall 2018 GoMMAPPS vessel survey.

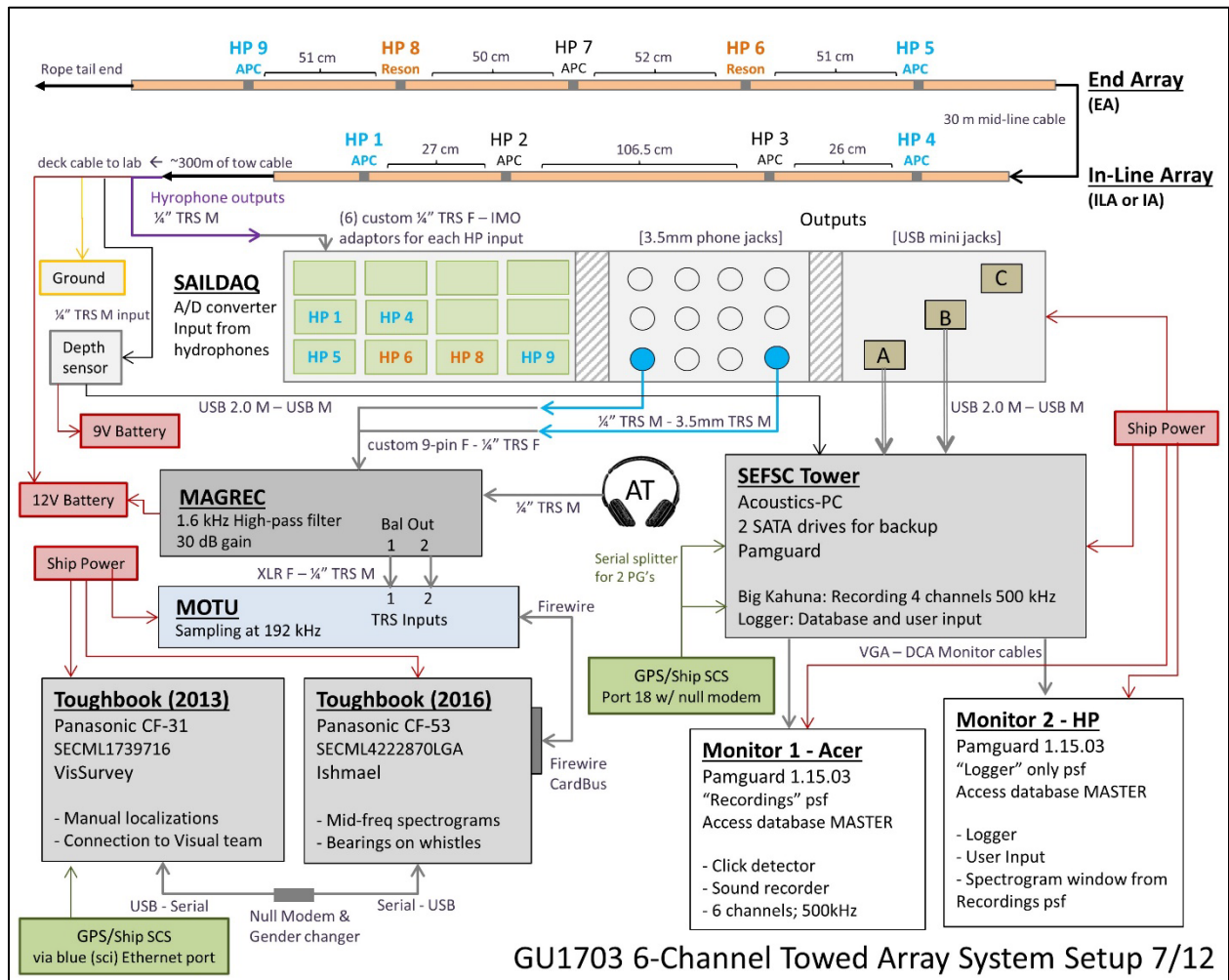

Figure B-4. Diagram of 6-channel towed array setup used during the summer 2017 GoMMAPPS vessel survey.

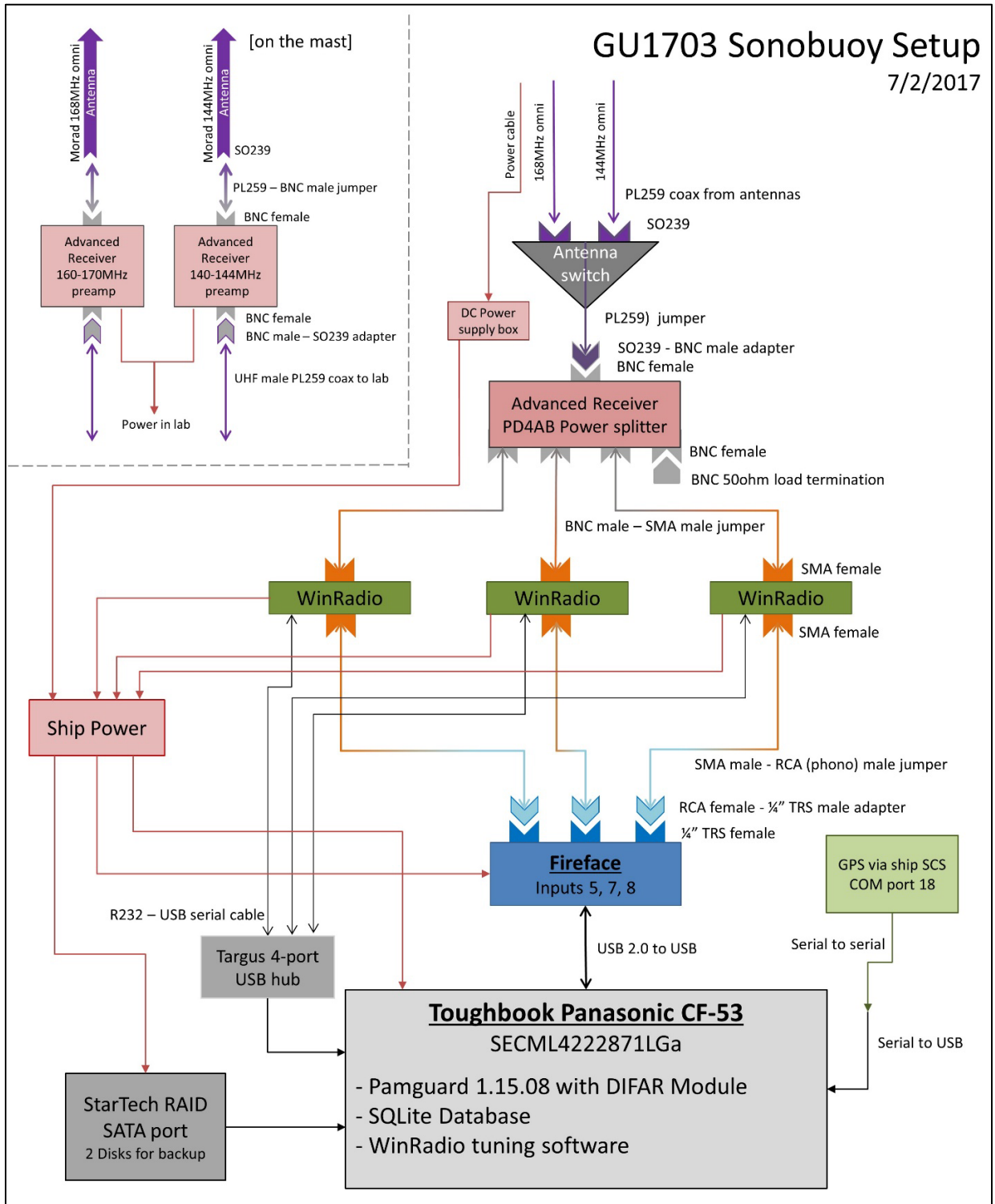

Figure B-5. Diagram of sonobuoy setup used during the summer 2017 GoMMAPPS vessel survey.

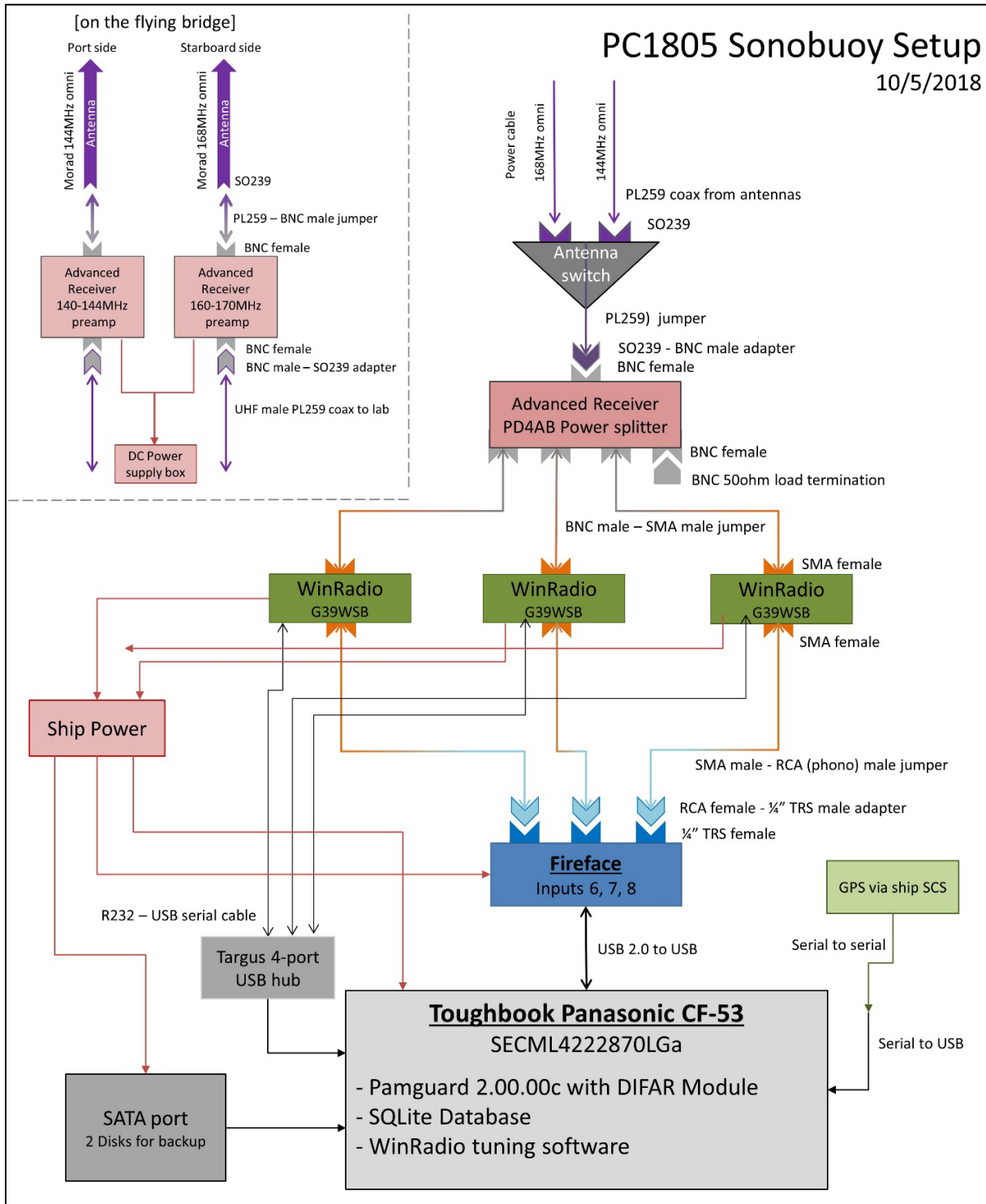

Figure B-6. Diagram of sonobuoy setup used during the summer/fall 2018 GoMMAPPS vessel survey.

Appendix E: Sperm Whale Acoustic Abundance Estimate Detailed Results

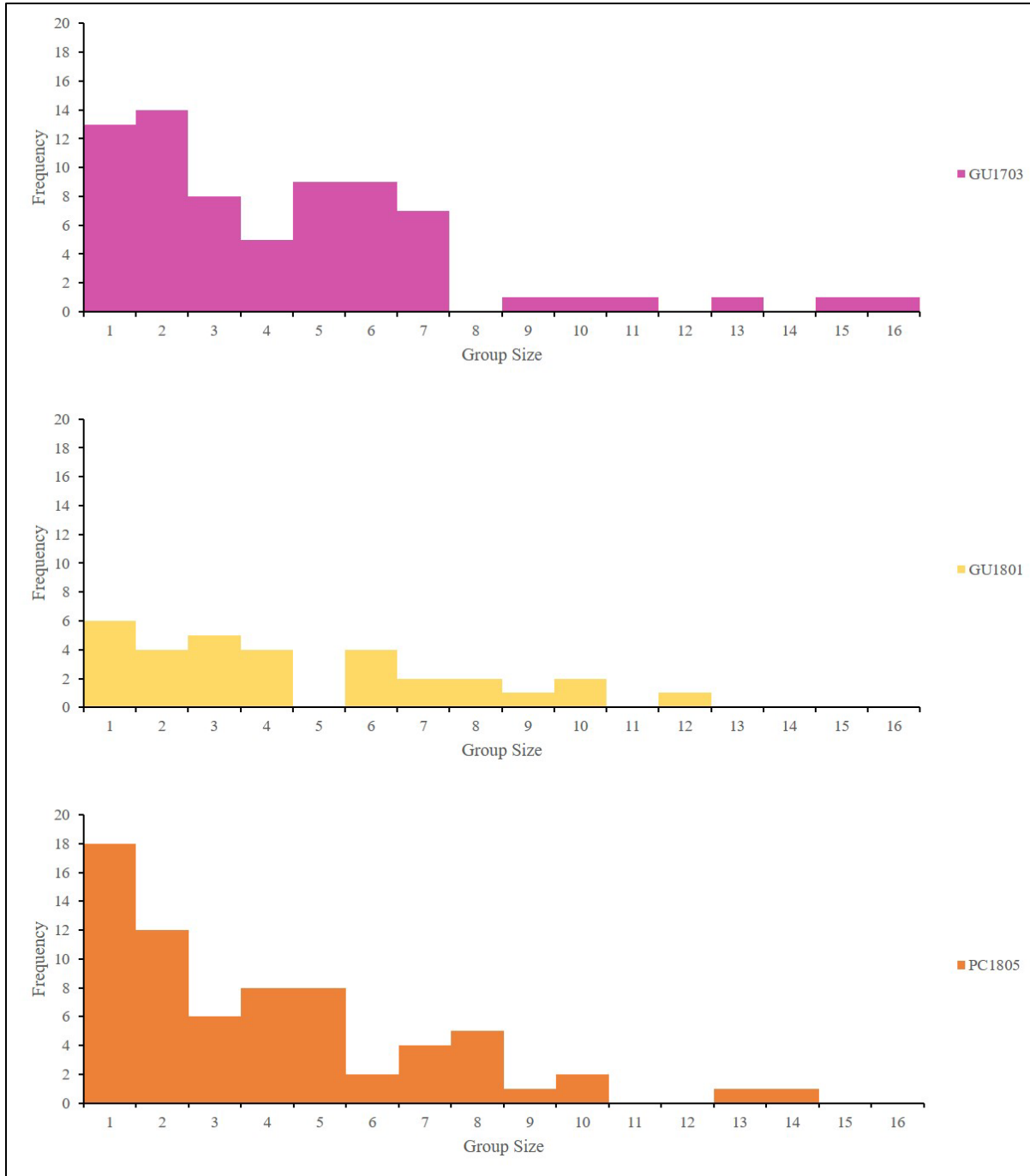

Figure E-1. Histograms of sperm whale group size.

Table E-1. Models selected as best fit for detection functions from the three surveys

Parameter	Point Estimate	Standard Error	CV	95% CI lower	95% CI upper
GU1703: Hazard rate key model					
$k(y) = 1 - \text{Exp}(-(y/A(1))^{-A(2)})$					
A(1)	5.831	0.304	-	-	-
A(2)	6.203	1.746	-	-	-
f(0)	0.157	0.006	0.037	0.146	0.169
p	0.776	0.028	0.037	0.722	0.834
ESW	6.365	0.232	0.037	5.924	6.840
GU1801: Uniform key model, cosine adjustment (order 1)					
$k(y) = 1/W$					
A(1)	0.712	0.095	-	-	-
f(0)	0.323	0.018	0.056	0.289	0.360
p	0.584	0.032	0.056	0.523	0.652
ESW	3.096	0.172	0.056	2.774	3.456
PC1805: half-normal key model					
$k(y) = \text{Exp}(-y^2/(2*A(1)^2))$					
A(1)	3.155	0.300	-	-	-
f(0)	0.268	0.019	0.070	0.233	0.308
p	0.619	0.044	0.070	0.539	0.711
ESW	3.732	0.262	0.070	3.249	4.287

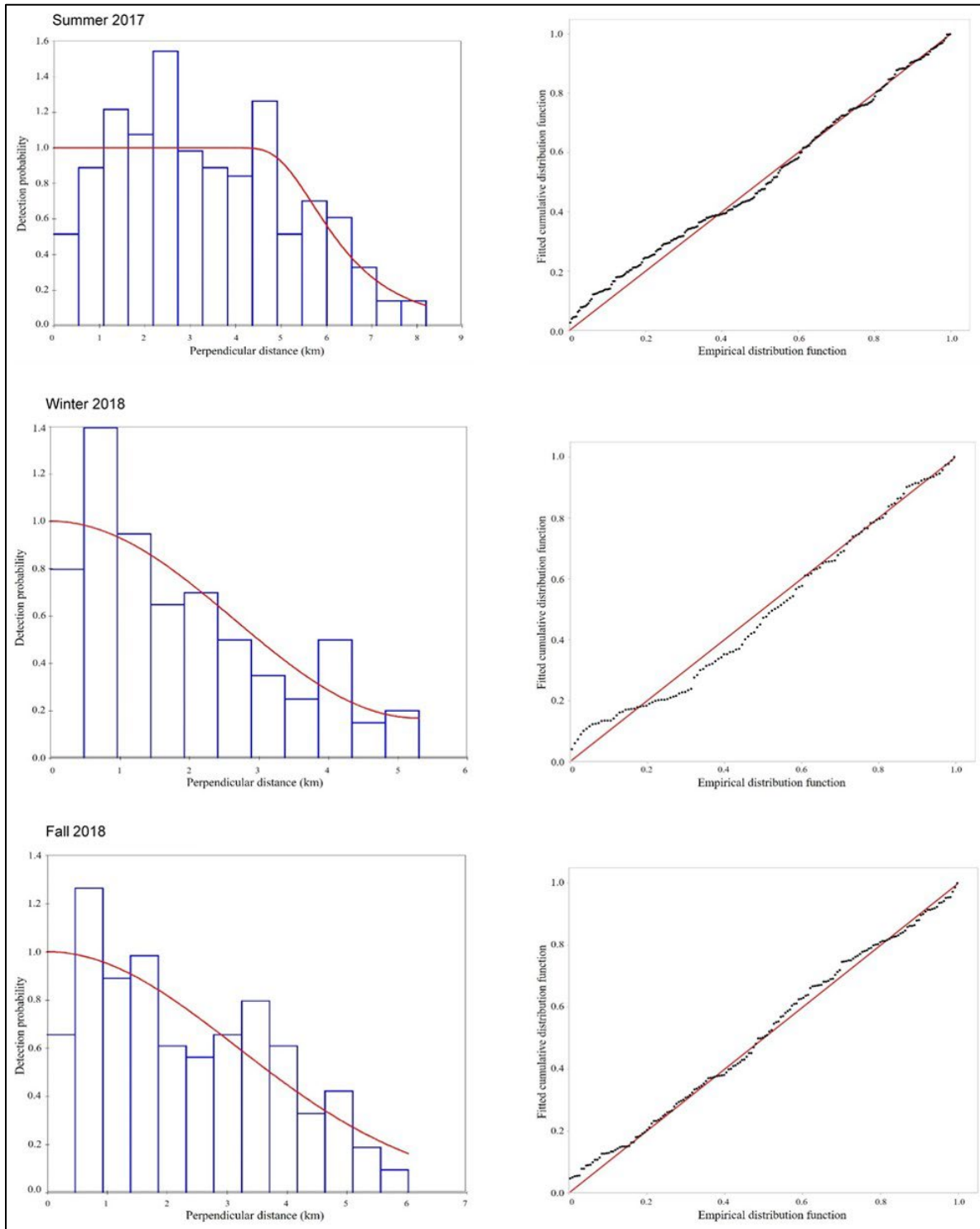

Figure E-2. Histograms of perpendicular distances with best fit detection function models and associated Q-Q plots for acoustically localized sperm whales on the three seasonal surveys.

Table E-2. Kolmogorov-Smirnov goodness of fit tests of detection function model fits for sperm whale acoustic abundance estimates from the three seasonal GoMMAPPS surveys

	K-S GOF test	K-S GOF p-value	Cramer-von Mises test	Cramer-von Mises p-value
Summer 2017	0.0605	0.3320	0.1677	0.35
Winter 2018	0.0793	0.3915	0.1614	0.35
Summer/Fall 2018	0.0491	0.8007	0.0769	0.72

Table E-3. Sperm whale acoustic encounter rates

	GU1703				GU1801				PC1805			
	Survey	East	Central	West	Survey	East	Central	West	Survey	East	Central	West
Effort (km)	7021.1	2628.5	3858.8	533.8	5209.5	1957.8	2744.3	507.4	6378.2	2398.7	3441.1	538.4
Samples (n)	86	38	40	8	61	24	30	7	96	40	49	7
Width (km)	8.20	8.20	8.20	8.20	5.30	5.30	5.30	5.30	6.03	6.03	6.03	6.03
Observations (n)	249	77	83	89	129	27	86	16	172	7	136	29
Percentage of Variance (D)												
Det Prob		0.9	2.8	2.4		0.9	1.8	0.7		1.5	6.8	2.7
Enc Rate		99.1	97.2	97.6		99.1	98.2	99.3		98.5	93.2	97.3
Encounter rate (n/km)		0.029	0.022	0.167		0.014	0.031	0.032		0.003	0.040	0.054
CV		0.380	0.214	0.234		0.569	0.414	0.685		0.561	0.261	0.419
df		37	39	7		23	29	6		39	48	6
95% CI lower		0.014	0.014	0.097		0.005	0.014	0.007		0.001	0.024	0.020
95% CI upper		0.062	0.033	0.288		0.041	0.071	0.144		0.008	0.066	0.144



Department of the Interior (DOI)

The Department of the Interior protects and manages the Nation's natural resources and cultural heritage; provides scientific and other information about those resources; and honors the Nation's trust responsibilities or special commitments to American Indians, Alaska Natives, and affiliated island communities.



Bureau of Ocean Energy Management (BOEM)

The mission of the Bureau of Ocean Energy Management is to manage development of U.S. Outer Continental Shelf energy and mineral resources in an environmentally and economically responsible way.

BOEM Environmental Studies Program

The mission of the Environmental Studies Program is to provide the information needed to predict, assess, and manage impacts from offshore energy and marine mineral **exploration**, development, and production activities on human, marine, and coastal environments. The proposal, selection, research, review, collaboration, production, and dissemination of each of BOEM's Environmental Studies follows the DOI Code of Scientific and Scholarly Conduct, in support of a culture of scientific and professional integrity, as set out in the DOI Departmental Manual (305 DM 3).